

# EMOTIVA®



# BASX

Power Amplifier User Manual



# Important Safety Precautions and Explanation of Symbols



The exclamation point within an equilateral triangle is intended to alert the user to the presence of important installation, operation, and service instructions in this manual.



The lightning flash with arrowhead symbol within an equilateral triangle is intended to alert the user to the presence of uninsulated dangerous voltages within the enclosure that may be of sufficient magnitude to constitute a risk of electrical shock to the user.

Please read this manual thoroughly before attempting to install, configure, or operate the BASX power amplifier. After successful installation and configuration of the BASX power amplifier, be sure to retain this manual in a safe place for future reference.

Safety is a key component to a long lasting and trouble free installation. Please read and follow all instructions and heed all warnings on the BASX amplifier and in this manual. The vast majority of the subsequent safety precautions are common sense. If you are not comfortable with the installation of audio/video entertainment equipment, you should seek the services of a qualified installation professional or call us for help.



**WARNING: TO REDUCE THE RISK OF FIRE OR ELECTRIC SHOCK, DO NOT USE THE BASX AMPLIFIER NEAR WATER OR IN WET LOCATIONS, DO NOT EXPOSE IT TO RAIN OR MOISTURE, DO NOT EXPOSE IT TO DRIPPING OR SPLASHING FROM OTHER SOURCES, AND ENSURE THAT NO OBJECTS FILLED WITH LIQUIDS (SUCH AS VASES) ARE PLACED ON IT. DOING SO MAY RESULT IN DAMAGE TO THE UNIT AND THE RISK OF ELECTRIC SHOCK, WHICH MAY RESULT IN BODILY INJURY OR DEATH.**



**WARNING: TO REDUCE THE RISK OF ELECTRIC SHOCK, DO NOT REMOVE THE COVER FROM THE BASX AMPLIFIER. THERE ARE NO USER-SERVICEABLE PARTS INSIDE THE UNIT. REFER ALL SERVICE TO QUALIFIED SERVICE PERSONNEL.**

Do not install the BASX amplifier near or above any heat sources such as radiators, heating vents, or other apparatus' that produce heat. Do not block any ventilation openings or heat sinks. Avoid installing the unit directly above other heat-producing equipment unless sufficient ventilation or forced-air cooling is provided.

Do not install the BASX amplifier in locations without proper ventilation. The BASX amplifier should not be operated on a bed, sofa, rug, or similar surface that may block vents. The unit should not be installed in an enclosed location such as a bookcase, cabinet, or closed equipment rack unless sufficient forced-air ventilation is provided.

Always install your BASX amplifier according to the manufacturer's instructions and only use attachments or accessories specified by the manufacturer.

Do not install the BASX amplifier on any stand, shelf, or other piece of furniture that is unable to support its weight. If a cart is used to move the unit, use caution to avoid injury from tip-over.

Connect the BASX amplifier only to power sources of the correct voltage (as shown in this manual and on the BASX amplifier unit).

Protect power supply cables from being pinched, walked on, or otherwise damaged. Be especially careful where the power cable enters the power outlet and the unit.

Only connect the BASX amplifier to an electrical outlet or extension cord of appropriate type and rating.

DO NOT defeat the safety purpose of a grounding or polarized plug by removing ground pins or using unsafe adapters. A polarized plug has two blades - one wider than the other. A grounding plug has a third ground prong in addition to the two main conductors. The wide blade or third grounding prong is provided for your safety. If the provided plug does not fit your outlet, consult an electrician to replace your obsolete outlet. If you replace the power cord, only use one of similar type and equal or greater current rating.

The power cable for the BASX amplifier should be unplugged from the outlet during severe electrical storms, or when unused for a long period of time.

Only replace the fuse(s) in the BASX amplifier with fuse(s) of proper value and voltage rating.



The BASX should only be cleaned as directed in the manual. Avoid spraying liquids directly onto the unit and NEVER spray liquids into the vents. Care should be taken so that small objects do not fall into the inside of the unit.



You should seek service for your BASX amplifier by qualified service personnel if any of the following occur:

1. The power-supply cord or the plug has been damaged.
2. Objects or liquid have fallen or spilled into the vents.
3. The unit has been exposed to rain.
4. The unit exhibits a marked change in performance.
5. The unit has been dropped, or its enclosure or chassis is damaged.

**NOTE: TO COMPLETELY DISCONNECT THE BASX AMPLIFIER FROM THE AC POWER MAINS, DISCONNECT THE AC POWER CORD FROM THE AC RECEPTACLE.**

**NOTE: THE POWER CORD ON THE BASX AMPLIFIER MUST REMAIN READILY ACCESSIBLE AT ALL TIMES.**

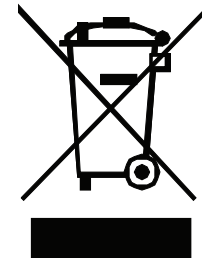



## **BASX A2 / A2mini / A3 / A4 / A5 / A7 Power Amplifiers**

### **Contents**

Important Safety Precautions and Explanation of Symbols

BASX A2 / A2mini / A3 / A4 / A5 / A7 Power Amplifiers .....	1
Introduction .....	3
About This Manual.....	4
Features .....	5
Unpacking.....	7
BASX Amplifier Family.....	8
BASX A2 / A3 / A4 / A5 / A7 Front Panel.....	9
BASX A2 / A3 / A4 / A5 / A7 Rear Panel .....	10
BASX A2mini Front Panel .....	12
BASX A2mini Rear Panel.....	13
BASX A2mini Headphone Output.....	15
Quick Start .....	16
Connections .....	17
Care and Maintenance .....	18
Specifications.....	19
Troubleshooting .....	22
Emotiva Audio Corporation Three-Year Limited Warranty .....	23
Notes.....	26



# BASX A2 / A2mini / A3 / A4 / A5 / A7

---

## Introduction

Thank you for purchasing one of our new Emotiva BASX amplifiers.

Our BASX product line is dedicated to the philosophy that high-quality products that deliver true audiophile sound quality don't need to be expensive to buy or complicated to configure and enjoy. Our BASX amplifiers give you great sound quality, excellent technical performance, and outstanding value.

The BASX A2, A3, A4, A5, and A6 amplifiers all use a "classical audiophile architecture", centered around a heavy-duty linear power supply, class A/B amplification, and the high current capability you need to get great sound with even difficult to drive speakers. We've paid special attention to important details like heavy-duty audiophile grade binding posts and carefully laid out signal paths. And we've also included important high-end features like differential inputs, automatic line voltage detection, and microprocessor controlled status indicators and fault protection.

The BASX A2mini offers some special features that set it apart from the other members of the BASX amplifier family. The amplifier section of the A2mini offers the same class A/B performance and sound quality as the other BASX amps. However, the A2mini offers a choice of fixed or variable gain, via a front panel Volume control, and a full-sized 1/4" front panel headphone jack. The BASX A2mini is housed in a compact half-rack-width chassis, and uses a high performance switch mode power supply, rather than the linear power supplies used in the other BASX model amps.

The BASX A2mini also offers another special feature which serious headphone aficionados will appreciate: A headphone output which is derived from the main amplifier outputs via a set of high quality, low noise, series resistors. This enables the A2mini to offer the same listening experience that headphone lovers prize in high-end vintage equipment, only with the vastly improved performance made possible by the modern circuitry in the A2mini. These series resistors can also be bypassed by installing a pair of jumpers, allowing owners of high impedance headphones or extremely low efficiency planars the ability to connect the headphone output directly to the outputs of the main amplifiers, for even better damping and more extreme output capabilities.

If you need superb sound, excellent build quality, and outstanding value, then you've come to the right place - Emotiva BASX.

Happy listening!

The Emotiva Team

## About This Manual

This manual will provide you with the information you need to get started enjoying your BASX power amplifier.

We suggest that you read through the entire manual; we kept things as short and direct as possible. Even if you're an expert user, you will probably find some interesting information and useful suggestions.

If you're really in a hurry to get started, please read the Quick Start section (on page 16); you may then read the remainder of the manual at your leisure.

You may wish to keep a copy of this manual with your records, and record serial numbers or other purchase information on the Notes page at the back.



# BASX A2 / A2mini / A3 / A4 / A5 / A7

## Features

All of the amplifiers in our BASX family are true audiophile-grade power amplifiers. Each model is designed to sound superb and provide years of trouble-free listening enjoyment.

Our BASX A2, A3, A4, A5, and A7 all feature our fully discrete, high-current, short signal path class A/B output section, and heavy duty linear power supplies. The A2 is the ideal choice if you need two channels of high quality amplification. The A5 and A7 are ideal if you need a great sounding economical amplifier to power a 5.1 or 7.1 channel system. The A3 provides exactly the number of channels you need to upgrade a two channel system to 5.1 channel surround sound. And, of course, the A4 is the perfect choice for powering a set of height speakers.

The A2mini offers the same audiophile quality class A/B output section as our other BASX amps, in a more compact form factor, and powered by a highly efficient precision switch mode power supply. The A2mini also adds several extra features, including the choice of either fixed or variable gain, a front panel Volume control, and a full-sized 1/4" headphone output with some special capabilities that will be especially appreciated by true headphone aficionados.

Welcome to the BASX series of amplifiers... proof that you can still get true audiophile sound quality, all the power you need to get great sound from even difficult to drive speakers, and real value... all in an affordable, attractive, well made package.

## *Features of the new BASX series power amplifiers:*

- **True audiophile-quality sound** - as with all of our amplifiers, the BASX amplifiers were designed first and foremost to sound superb in all types of audio systems.
- **Great sounding Class A/B output stage** - ensures smooth detailed sound and incredibly natural imaging without a trace of harshness or strain.
- **Heavy duty linear power supply (A2, A3, A4, A5, A7)** - with an oversized toroidal power transformer and plenty of current capacity to drive even difficult speakers.
- **Top quality parts and construction throughout** - promise years of reliable service.
- **Totally stable** - designed for use in the real world, with real speakers.
- **Heavy steel chassis with milled aluminum face plate** - provide strength and rugged good looks.
- **Heavy duty insulated five-way speaker binding posts** - allow you to use a wide range of speaker cables with bare wires, lugs, or banana plugs.
- **Remote trigger input and output** - allow the BASX power amps to be turned on by trigger-enabled equipment, and to activate other trigger-enabled equipment.
- **Audiophile-grade fault protection** - entirely transparent under normal conditions, yet protects the amp and your other equipment from all common fault conditions.
- **Universal AC line voltage operation** - the BASX amplifiers are designed to operate on either 115 VAC or 230 VAC at 50/60 Hz, and automatically detect and configure themselves to operate with your local line voltage.

# BASX A2 / A2mini / A3 / A4 / A5 / A7

---

- **Auto-On Power Switching (only on the A2 and A2mini)**- enables you to configure the BASX A2 and A2m to automatically turn on when an audio input is detected.
- **Standard IEC power inlet (A2, A3, A4, A5,A7)**- fits all standard and audiophile IEC power cables.
- **Full three year warranty** - ensures that you'll be able to enjoy your BASX power amp for years to come.

## ***Features unique to the BASX A2mini:***

- **Classic style headphone output** - driven from the main amplifier outputs via a set of high-quality series resistors; delivers the same sound signature as the highly-prized headphone outputs on high-end vintage equipment.
- **Direct headphone output option** - allows you to route the main speaker outputs of the A2m directly to the headphone jack to drive both high impedance headphones and low-efficiency planars with even better damping and more extreme output capabilities.
- **Highly efficient precision SMPS (switch mode power supply)** - delivers plenty of power, in a compact form factor, and offers cool efficient operation.
- **Flexible power switching** - allows you to configure the A2mini to remain on or to switch on automatically when it detects an incoming audio signal or a trigger signal from your processor or AVR.
- **Choice of fixed or variable gain** - allow you to configure the A2mini as either a fixed gain power amplifier or a variable gain "integrated amplifier". The BASX A2mini features a precision digitally controlled analog ladder network Volume control that combines low noise and distortion with excellent channel tracking.
- **Front panel volume control** - features a knurled aluminum knob which operates a precision digitally controlled analog ladder network Volume control that combines low noise and distortion with excellent channel tracking.

You can find more information about the entire BASX line of products on our website at [www.emotiva.com](http://www.emotiva.com) - which you can also access by scanning the QR code below.



## Unpacking

Your BASX amplifier was carefully packed and should reach you in perfect condition. If you notice any shipping damage or other issues when you unpack it, please contact Emotiva immediately.

Gently remove your BASX amp from the packing carton and remove all wrappings and shipping material.

It is important to save the box and all packing materials in case your power amp ever needs to be moved or shipped back to the factory for service.

We truly value customer feedback and would like to hear from you.

# BASX A2 / A2mini / A3 / A4 / A5 / A7

## BASX Amplifier Family

**BASX A2**

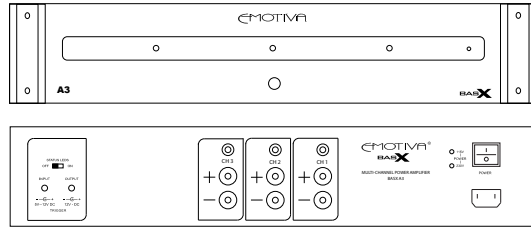
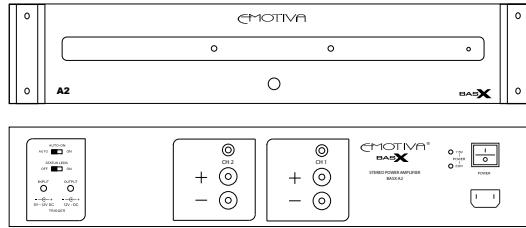

**BASX A3**

**BASX A4**

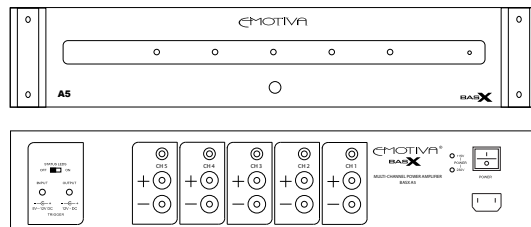
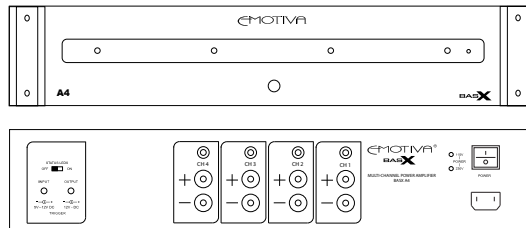

**BASX A5**

**BASX A7**

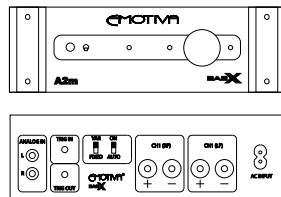
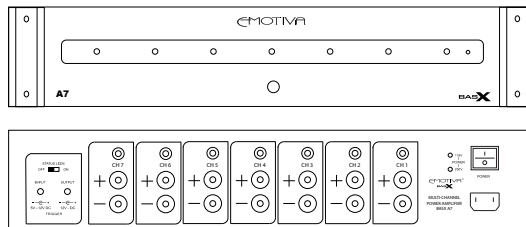

**BASX A2mini**

# BASX A2 / A2mini / A3 / A4 / A5 / A7

## BASX A2 / A3 / A4 / A5 / A7 Front Panel

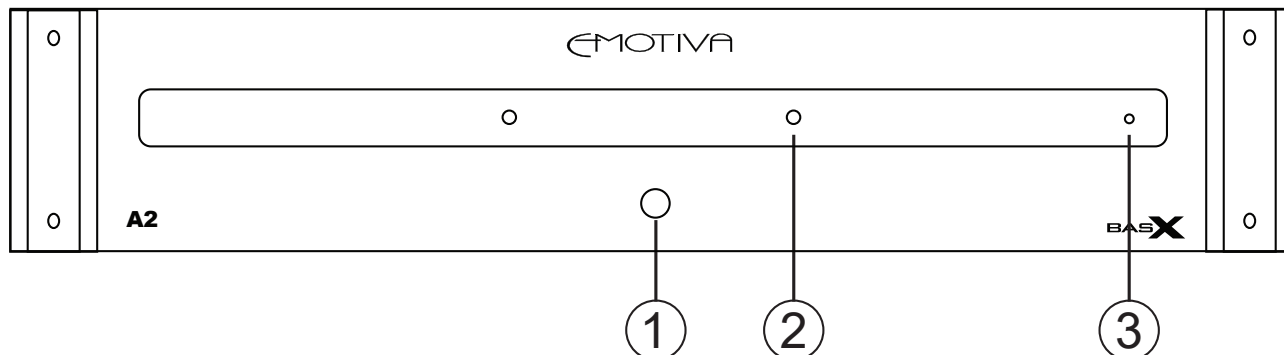

### Note:

*The BASX A2, A3, A4, A5, and A7 all have similar front panels. The only difference is the number of Status LEDs on each (one for each channel). The BASX A2 is shown here for illustration.*

## 1. Standby Button

Press to switch the amplifier On; press again to return to Standby.

**Note:** *In order for the BASX amplifier to operate, the rear panel AC Power Switch must first be turned On.*

## 2. Status Display Window And Status LEDs

This window houses the Standby LED and Status LEDs.

**When the Amplifier is OFF no LEDs will be illuminated.**

**When the Amplifier is ON, and in Standby Mode, only the Standby LED will be lit amber.**

**When the Amplifier is ON, and NOT in Standby Mode, the Standby LED will NOT be lit.**

**When the rear panel Status LED Switch is set to ON -**

**when the Amplifier is ON and running the Status LEDs will be illuminated blue.**

**When the rear panel Status LED Switch is set to OFF -**

**when the Amplifier is ON and running the Status LEDs will NOT be lit (NO LEDs will be lit).**

**When the Amplifier experiences a Fault condition the Status LEDs will flash red while the Standby LED flashes amber.**

## 3. Standby LED

This LED illuminates amber when the amplifier is powered ON and in Standby Mode.

# BASX A2 / A2mini / A3 / A4 / A5 / A7

## BASX A2 / A3 / A4 / A5 / A7 Rear Panel

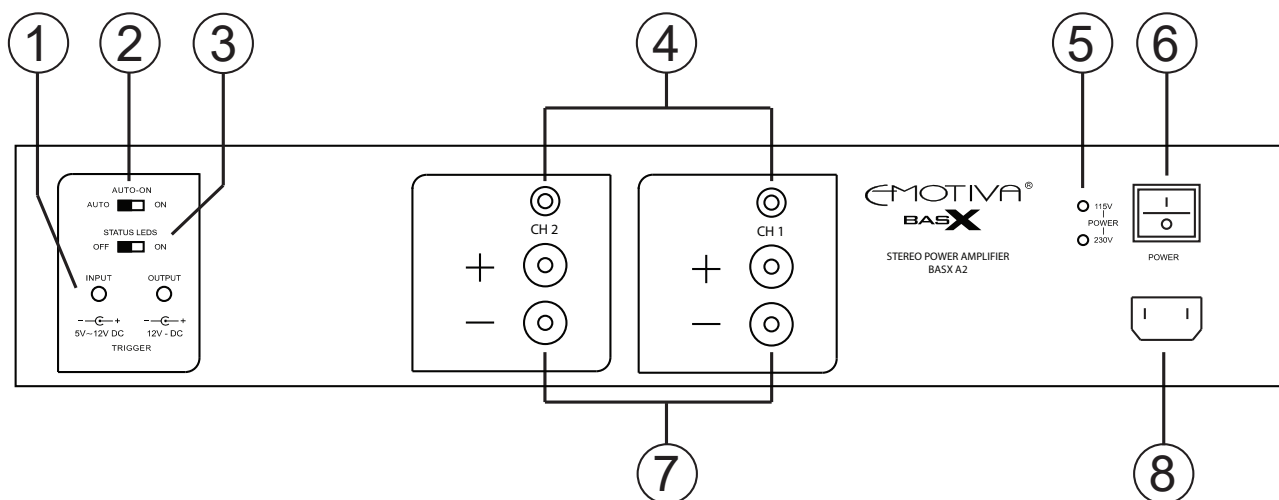

### Note:

**Most of the features and controls on the rear panel of each BASX amplifier model are the same. Each model has one Unbalanced RCA Input and one Speaker Output per channel. HOWEVER ONLY THE BASX A2 INCLUDES THE CONTROL SWITCH FOR THE AUTO-ON FEATURE. The BASX A2 is shown here for illustration.**

## 1. Trigger Input and Trigger Output

The BASX power amplifier is switched On (from Standby) when a trigger signal is presented at the Trigger Input; the BASX power amp returns to Standby when the trigger signal is removed. When the BASX power amp is on, a 12 VDC signal is sent from the Trigger Output to turn on other devices.

## 2. Auto-On Switch

### Note:

**ONLY THE BASX A2 OFFERS THE AUTO-ON FEATURE.**

This switch enables the amplifier's Auto-On feature. When this feature is enabled, and the amplifier is in Standby, the amplifier will switch ON when an audio signal is detected, and switch OFF again after a brief delay when the audio signal is no longer present.

## 3. Status LEDs Switch

Disables the front panel status LEDs when set to Off.

## **4. Unbalanced Inputs**

The BASX power amplifier has independent unbalanced inputs for each channel.

**Note:** *All of the channels on each BASX power amp are the same, so you may assign any channel on the amplifier to any audio channel you find convenient.*

## **5. AC Power Voltage LEDs**

The BASX power amps are designed to operate on either 115 VAC or 230 VAC, and automatically detect and configure themselves to operate with your local line voltage. These LEDs tell you which line voltage the BASX amplifier has detected.

## **6. AC Power Switch**

Switches the main AC power to the BASX power amp On and Off. When this switch is Off, no controls operate (the BASX power amp cannot be turned On from the front panel or by a trigger signal).

## **7. Speaker Terminals**

The speaker outputs on the BASX power amp are heavy duty five-way binding posts, which accept a variety of speaker cables - including those with banana plugs, spade lugs, or bare ends.

## **8. IEC Power Cord Receptacle**

The BASX power amp can be powered by any receptacle that provides either 115 VAC or 230 VAC at 50/60 Hz. This receptacle accepts a standard removable IEC AC power cable (a high-quality commercial power cable is included).

## BASX A2mini Front Panel

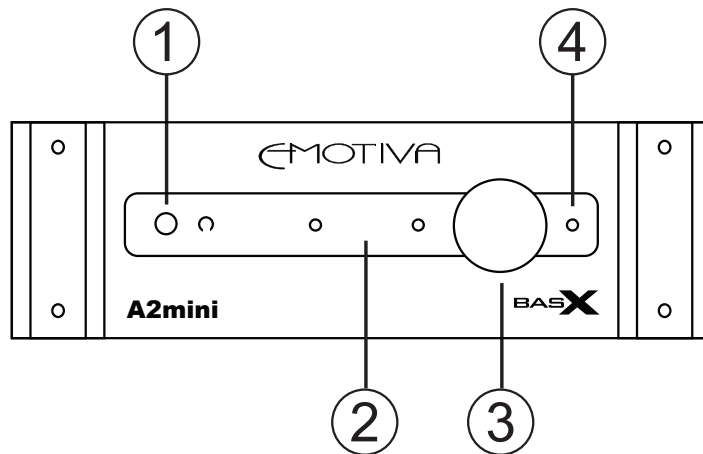

### 1. Headphone Output

Use this headphone output to connect a pair of high quality headphones.

**Note:** The main speaker output is disabled when headphones are inserted into the headphone output.

**Note:** Please see BASX A2mini Headphone Output for important information about the headphone output on the A2mini.

### 2. Status LEDs

When the Amplifier is OFF or in STANDBY the Status LEDs will not be lit.

When the Amplifier is ON, the Status LEDs and the Volume knob accent will glow blue.

When the Amplifier is ON, but MUTED, the Status LEDs will pulsate blue.

When a FAULT condition occurs the Status LEDs will flash red.

### 3. Volume / Mute Control

The Volume Control is used to adjust both the main and headphone output volume.

Press the Volume knob once to MUTE the output; press it again to UNMUTE the output.

**Note:** The setting of the Volume knob controls the levels of BOTH THE MAIN OUTPUTS AND HEADPHONE OUTPUTS when the rear panel Var / Fixed switch is set to VARIABLE. When the rear panel Var / Fixed switch is set to Fixed, the A2mini has a fixed gain of 29 dB, and the Volume control has no effect. However, if you change the setting of the Volume knob while the A2mini is set to Fixed Volume, that setting will take effect when you switch the A2mini back to Variable.

### 4. Standby LED

The Standby LED glows amber when the BASX A2mini is in STANDBY.



## BASX A2mini Rear Panel

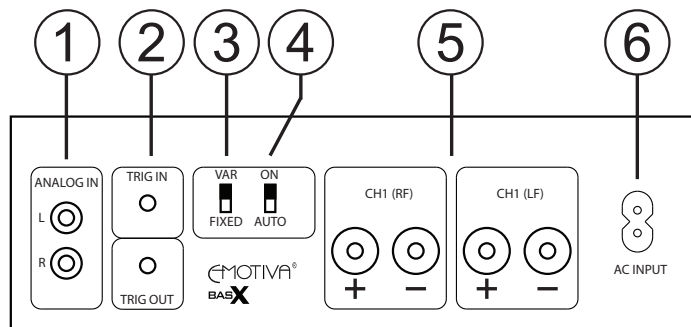

### 1. Line Level Stereo Input

Use this input to connect any line level stereo source to the BASX A2mini.

### 2. Trigger Input and Trigger Output

When the BASX A2mini is in Auto Mode, the A2mini will turn On when it senses an audio signal on its input, or when a trigger signal is presented at the Trigger Input. The A2mini will return to Standby when the trigger signal is removed and no audio has been present for several minutes. When the BASX power amp is on, a 12 VDC signal is sent from the Trigger Output to turn on other trigger-enabled devices.

### 3. Variable / Fixed Level Switch

**When this switch is in the FIXED position the BASX A2mini has a fixed gain of 29 dB (the same as our other BASX power amps).**

**When this switch is in the VARIABLE position the output level of the A2mini is controlled by the front panel Volume control.**

**Note: When the rear panel Var / Fixed switch is set to the VARIABLE setting the Volume knob controls the levels of BOTH THE MAIN OUTPUTS AND THE HEADPHONE OUTPUTS. When the rear panel Var / Fixed switch is set to Fixed, the A2mini has a fixed gain of 29 dB, and the Volume control has no effect on either. However, if you change the setting of the Volume knob while the A2mini is set to Fixed Volume, that setting will take effect when you switch the A2mini back to Variable.**

**! WARNING! WHEN THE A2mini IS SWITCHED TO FIXED MODE IT OFFERS A FIXED GAIN OF 29 dB. WHEN SWITCHED TO VARIABLE MODE, THE LEVEL WILL JUMP IMMEDIATELY TO THE LEVEL SET BY THE VOLUME CONTROL, WHERE THE GAIN MAY BE ANYWHERE BETWEEN 0 AND 32. BE ESPECIALLY CAREFUL WHEN USING HEADPHONES - PARTICULARLY IF YOU ARE USING THE HIGH POWER JUMPER OPTION ON THE HEADPHONE OUTPUTS.**

## **4. Auto-On Switch**

This switch enables the amplifier's Auto-On feature. When this switch is set to ON the amplifier will remain On. When this switch is set to AUTO, the amplifier will normally remain in Standby, but will switch ON when an audio signal is detected, and switch OFF again after a brief delay when the audio signal is no longer present.

## **5. Speaker Outputs**

The speaker outputs on the BASX A2mini use heavy duty audiophile grade five-way binding posts. They accept speaker cables terminated with banana plugs, spade lugs, or bare wire.

## **6. Power Cord Receptacle**

Use this receptacle to attach the included power cable for the BASX A2mini.

## BASX A2mini Headphone Output

The BASX A2mini has very special headphone circuitry, which will be of particular interest to headphone aficionados and lovers of classic vintage equipment.

The headphone output on the BASX A2mini is powered by the main output amplifiers, after being passed through a set of high-quality series resistors. This circuit topology is typical of the headphone outputs in highly prized vintage audio equipment, and offers a slightly different listening experience from modern headphone amplifiers. Because this classic output topology is powered by the advanced circuitry of the A2mini, with its extremely low noise and distortion, the end result is a smooth yet detailed sound signature rarely available anywhere else - at any price.

The A2mini also offers another very special option that will be of particular interest to owners of difficult to drive high impedance headphones and low efficiency planars. In order to deliver optimum performance, many such headphones must be driven directly by "a speaker amplifier". Because the sound quality and power output of the A2mini are ideal for use with these headphones, we've included an option to bypass the series resistors on the headphone output, and connect the front panel headphone output directly to the speaker outputs.

Because this is a special option, and must be used carefully, it can only be accessed by installing a pair of internal jumpers inside the BASX A2mini.

**! WARNING! WHEN JUMPERS ARE INSTALLED, THE FULL SPEAKER OUTPUT SIGNAL WILL BE ROUTED TO THE FRONT PANEL HEADPHONE OUTPUT. This is equivalent to connecting your headphones directly to the speaker outputs. While this is appropriate for driving high impedance headphones and low efficiency planar headphones, EXTREME CAUTION should be used when adjusting the volume on the A2mini when these jumpers are in place. EMOTIVA ASSUMES NO LIABILITY FOR HEADPHONES DAMAGED BY USING THIS OPTION!**

**! ALWAYS DISCONNECT AC POWER CABLE FROM THE BASX A2mini BEFORE REMOVING COVER!**

To configure the Direct High Power Headphone Mode on the BASX A2mini, insert the included jumpers over the header pins as shown in the diagram (we suggest using tweezers or needle nosed pliers).

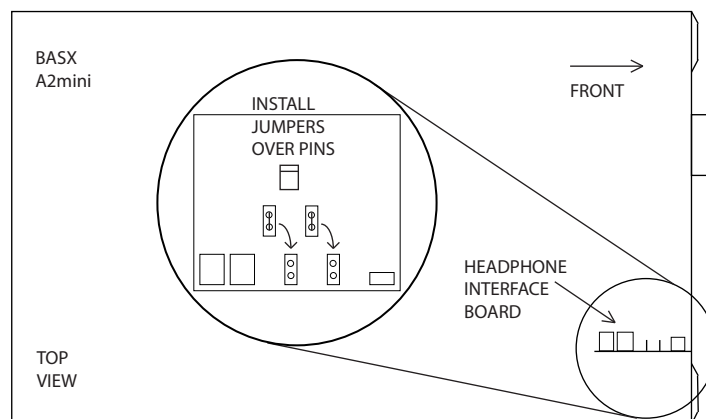

## Quick Start

To get the most from your BASX power amplifier we urge you to read the entire manual. If you just can't wait to listen to it, this section will cover the basics you need to get started.

- Find a secure location for your BASX power amplifier.
- Connect your BASX power amplifier to a signal source.
- Connect your BASX power amplifier to a set of speakers (4 ohm or 8 ohm) using reasonably heavy gauge speaker wires (at least 16 gauge).
- Find some music you *really* like to listen to.
- Turn on the AC Power switch and turn up the volume a bit!
- Enjoy!

While you're enjoying your BASX power amplifier, it would be a great time to read the rest of the manual to learn more about it.

## Connections

### *Connecting speakers to your BASX power amplifier*

Your BASX power amplifier has no special connection requirements; audiophile grade five-way binding posts are provided for speaker connections.

- **Always** turn off the amplifier before connecting or disconnecting speaker cables or signal source interconnects.
- **Always** verify that your speaker cables are firmly attached, and not shorted to each other or to any other cables, before powering up your BASX power amplifier.
- **Always** use high-quality speaker wire; 16-gauge or heavier.
- If you must use thinner wire, try to keep the length as short as possible.
- Be careful to wire all speakers “in phase” (the plus/red terminal on each speaker to the plus/red terminal on your amp).
- Try to use wires of equal length and gauge for both speakers in each pair (use the same gauge and length for both fronts, or for both surrounds; don’t use a long 16-gauge wire for one speaker and a short 10-gauge wire for the other).
- If you use stranded cables, use care to avoid short circuits (from stray strands touching).

### *Connecting an input source to your BASX power amplifier*

Your BASX power amplifier uses unbalanced (RCA) inputs. We suggest using reasonably high quality cables, keeping cables no longer than necessary, and avoiding running signal cables near power cables and speaker cables whenever possible.

DO NOT connect a digital signal to the inputs of your BASX power amplifier (or you may damage it or your speakers).

### *Connecting the Trigger Input and Trigger Output*

The Trigger Input accepts a 12 VDC (nominal) trigger signal from another device via a standard 1/8” mono plug. When the trigger is asserted, the BASX power amplifier will switch On; when the trigger is removed, the BASX power amp will return to Standby mode. The Trigger Output sends out 12 VDC whenever the main power to the BASX power amp is On (and NOT when it is in Standby mode) which can be used to switch on other units with trigger capabilities.

### *Line Voltage*

The BASX power amp can be powered by any receptacle that provides either 115 VAC or 230 VAC at 50/60 Hz. The BASX power amp will automatically detect the correct line voltage. A pair of LED indicators on the rear panel of the BASX A2, A3, A4, A5, and A7 will indicate which line voltage the BASX power amp has detected.

## Care and Maintenance

### *Periodic Maintenance*

Your BASX amplifier requires no periodic maintenance or calibration.

### *Cleaning your BASX amplifier*

- If necessary, the BASX amplifier should be cleaned gently with a soft rag.
- If something sticky gets on the front panel or case of the BASX amp, it should be cleaned with a mild cleaning solution applied to a soft rag, followed by wiping with a clean rag dampened with plain water and drying with a soft dry rag or cloth.

**Note: DO NOT spray water or cleaning solution directly onto the BASX amplifier or into the vents.**

### *Changing the internal power fuse (BASX A2mini ONLY)*

The BASX A2mini has an internal power supply fuse located on the power supply circuit board. If this fuse blows it should only be replaced with a 4A T type fuse (time delay / slo-blo).

# BASX A2 / A2mini / A3 / A4 / A5 / A7

---

## Specifications

*Note: The following specifications apply to all six models (BASX A2, A2mini, A3, A4, A5, A7) unless otherwise noted.*

## Power Output

**Power Output Per Channel; ALL channels driven:**

**A-2: 160 watts RMS / channel; 20 Hz - 20 kHz; THD < 0.1%; into 8 Ohms  
250 watts RMS / channel; 1 kHz; THD <1%; into 4 Ohms**

**A-2mini: 50 watts RMS / channel; 20 Hz - 20 kHz; THD < 0.1%; into 8 Ohms  
90 watts RMS / channel; 1 kHz; THD <1%; into 4 Ohms**

**A-3: 140 watts RMS / channel; 20 Hz - 20 kHz; THD < 0.1%; into 8 Ohms  
200 watts RMS / channel; 1 kHz; THD <1%; into 4 Ohms**

**A-4: 100 watts RMS / channel; 20 Hz - 20 kHz; THD < 0.1%; into 8 Ohms  
130 watts RMS / channel; 1 kHz; THD <1%; into 4 Ohms**

**A-5: 95 watts RMS / channel; 20 Hz - 20 kHz; THD < 0.02%; into 8 Ohms  
130 watts RMS / channel; 1 kHz; THD <1%; into 4 Ohms**

**A-7: 90 watts RMS / channel; 20 Hz - 20 kHz; THD < 0.02%; into 8 Ohms  
125 watts RMS / channel; 1 kHz; THD <1%; into 4 Ohms**

**Power Output Per Channel; TWO channels driven:**

**A-3: 150 watts RMS / channel into 8 Ohms; 250 watts RMS / channel into 4 Ohms**

**A-4: 100 watts RMS / channel into 8 Ohms; 175 watts RMS / channel into 4 Ohms**

**A-5: 120 watts RMS / channel into 8 Ohms; 175 watts RMS / channel into 4 Ohms**

**A-7: 120 watts RMS / channel into 8 Ohms; 175 watts RMS / channel into 4 Ohms**

## Input Sensitivity (for rated power; 8 Ohm load)

A2: 1.2 V.

A2mini: 0.7 V (Fixed); <0.5 V (Variable)

A3: 1.25 V.

A4: 1.2 V.

A5: 1.2 V.

A7: 1.2 V.

## Gain

ALL MODELS (includinges BASX A2mini in Fixed Volume mode): 29 dB.

BASX A2mini (in Variable Volume mode): up to 32 dB.

## Power Bandwidth (at rated power; 8 Ohm load)

20 Hz to 20 kHz (+ / - 0.07 dB) or better.

## ***Broad Band Frequency Response***

5 Hz to 80 kHz (+ 0 / - 1.8 dB).

## ***THD + noise***

< 0.02% (A-weighted); at rated power; 1 kHz; 8 Ohms.

## ***Signal to Noise Ratio (8 Ohm load)***

> 112 dB or better; referenced to rated power (A-weighted).

> 95 dB; referenced to 1 watt (A-weighted).

## ***Load Impedance***

Minimum Load Impedance: 4 Ohms; which equals one 4 Ohm load or two paralleled 8 Ohm loads.

Rated Load Impedance: 8 Ohms.

## ***Damping Factor (8 Ohm load)***

> 500.

## ***Speaker Output Connections***

Audiophile grade 5-way binding posts.

## ***Power Supply***

A2, A3, A4, A5, A7: Linear power supply with heavy duty toroidal transformer.

A2mini: High efficiency SMPS (switch mode power supply).

## ***Input Connections***

Unbalanced (RCA); one each per channel.

## ***Input Impedance***

27 kOhms.

## ***Trigger***

Trigger Input: 5 - 12 V (AC or DC); <10 mA input current required.

Trigger Output: 12 VDC; can drive any load up to 120 mA.

## ***Power Requirements***

A2, A3, A4, A5, A7: 115 VAC or 230 VAC @ 50 / 60 Hz (automatically detected).

A2mini: 100 VAC - 240 VAC @ 50/60 Hz.



# BASX A2 / A2mini / A3 / A4 / A5 / A7

## Protection

The BASX amplifier is protected against excessive operating temperature, shorted speaker connections, ground faults, and other common fault conditions.

## Dimensions:

BASX A2, A3, A4, A5, and A7:

17" wide x 4-1/4" high x 15-1/2" deep (unboxed; including feet).

17" wide x 3-1/2" high x 15-1/2" deep (unboxed; without feet).

BASX A2mini:

8-1/4" wide x 3" high x 14-1/4" deep (unboxed; including feet).

8-1/4" wide x 2-1/2" high x 14-1/4" deep (unboxed; without feet).

BASX A2, A3, A4, A5, and A7:

21" wide x 21" deep x 8" high (boxed)

## Weight

BASX A2: 25.2 lbs (unboxed)

BASX A2mini: 7.5 lbs (unboxed)

BASX A3: 25.2 lbs (unboxed)

BASX A4: 25.2 lbs (unboxed)

BASX A5: 25.2 lbs (unboxed)

BASX A7: 28 lbs (unboxed)

\* For boxed weight, add 7 lbs to the above weights

## Mounting / Feet

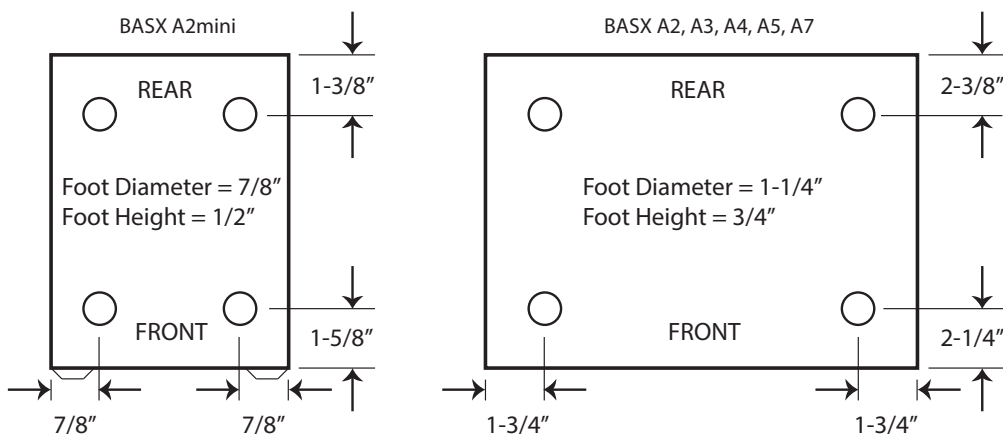

## Troubleshooting

Your BASX amplifier was carefully designed and manufactured from high-quality precision components to ensure years of trouble free operation. We really doubt you'll ever have any problems with your BASX amp, but if you do, here are a few things you could try:

**Problem: No output (nothing is lit).**

*Reason: You have no AC power.*

- Verify that the rear panel AC Power switch is On.
- Verify that your AC power circuit is live.
- Verify that the line cord on your BASX amp is fully inserted and is tight.
- Check the internal AC power fuse (A2m only).

**Problem: Your BASX amplifier is operating normally, but none of the Status LEDs is lit.**

*Reason: The front panel status LEDs are turned off (all BASX models except A2m).*

- Set the Status LEDs switch on the rear panel to On.

**Problem: No sound or distorted sound is heard but there are NO flashing LEDs.**

*Your BASX amplifier is not indicating a fault condition.*

- Check your source.
- Check your speakers and speaker connections.
- If there is NO sound, verify that you have AC power, and that the AC Power Switch is ON.

**Problem: There is no sound; the Status LEDs are flashing.**

*Reason: Your BASX amplifier is in Protect mode, which indicates a fault condition.*

- Switch the rear panel AC Power switch Off and On to clear the Fault condition. (On the BASX A2m disconnect the power cord from the AC outlet for a few seconds.)
- If the fault remains, look for a shorted speaker cable or damaged speaker.
- Check your sources and source connections (a bad interconnect, DC on the input, or an otherwise bad source component can cause a fault).

**Problem: There is no sound; the blue Status LEDs are PULSATING slowly (A2m only).**

*Reason: Your BASX A2m is Muted.*

- Press the Volume knob to toggle Mute Mode Off.

**Problem (A2 and A2mini only): The Standby LED is lit amber, the BASX A2 or A2mini is set to Auto-On, and your BASX amplifier fails to come on when the source is playing.**

*Your BASX amplifier is NOT turning on when it senses an input signal.*

- Check your source and cables.
- Verify that the Auto-On Switch is set to the correct position.
- Try using a Trigger Cable.

## Emotiva Audio Corporation Three-Year Limited Warranty

### What does this warranty cover?

Emotiva Audio Corporation (Emotiva) warrants the BASX A2, BASX A2mini, BASX A3, BASX A4, BASX A5, and BASX A7 against defects in materials and workmanship. This warranty, and all rights provided hereunder, covers the original owner for a full three years, and may be transferred to a new owner by the original owner during the first year of ownership. In the event the original owner transfers ownership of the Product after the first year of ownership, but prior to the expiration of the applicable term described below, this Warranty shall terminate immediately upon such transfer of ownership.

This Warranty only applies to Products purchased directly from Emotiva or any of its Authorized Dealers or International Distributors.

Emotiva warrants any replacement product or part furnished hereunder against defects in materials and workmanship for the longer of the following: (i) the amount of time remaining under the original warranty, or (ii) 120 days from your receipt of the repaired or replaced product. The duration described in this paragraph is hereinafter referred to as the "Term".

TO THE FULLEST EXTENT PERMITTED BY LAW, ALL IMPLIED WARRANTIES RELATED TO THE ORIGINAL PRODUCT AND ANY REPLACEMENT PRODUCT OR PARTS (INCLUDING IMPLIED WARRANTIES OF MERCHANTABILITY AND FITNESS FOR A PARTICULAR PURPOSE) ARE EXPRESSLY LIMITED TO THE TERM OF THIS LIMITED WARRANTY. SOME STATES DO NOT ALLOW LIMITATIONS ON HOW LONG AN IMPLIED WARRANTY LASTS, SO THE ABOVE LIMITATION MAY NOT APPLY TO YOU.

The original owner must make a claim within the Term of the Warranty. A claim shall not be valid (and Emotiva has no obligation related to the claim) if it is not made within the Term and if it is not made in strict compliance with the requirements of the "How do you get service?" section.

### How long does this coverage last?

This warranty commences on the date of retail purchase by the original retail purchaser and runs for a period of three years thereafter. This warranty may be transferred once by the original owner during the initial one year of ownership, and is non-transferable thereafter to the original or subsequent owner during the Term. Emotiva warrants any replacement product or part furnished hereunder against defects in materials and workmanship for the longer of the following: (i) the amount of time remaining under the original warranty, or (ii) 120 days from your receipt of the repaired or replaced product. The duration described in this paragraph is hereinafter referred to as the "Term".

### What will Emotiva do?

Emotiva will, at its option, either: (i) repair the product, or (ii) replace the product with a new consumer product which is identical or reasonably equivalent (in Warrantor's sole discretion) to the product. In the event Warrantor, in its sole discretion, is unable to replace or repair the Product or it is not commercially practicable to do so, then: (i) if the claim was submitted during the first

# **BASX A2 / A2mini / A3 / A4 / A5 / A7**

---

365 days of the Term, Warrantor shall refund to you the purchase price that you paid for the Product; and (ii) if the claim was submitted after the first 365 days of the Term, Emotiva shall issue you a credit equal to the purchase price that you paid for the product. The credit may only be used for the purchase of merchandise from Emotiva, and cannot be used for freight charges.

When a Product or part is repaired or replaced, any replacement item becomes your property and the replaced item becomes Emotiva's property. When a refund or credit is given, the Product for which the refund or credit is provided must be returned to Emotiva and becomes Emotiva's property.

## **What is not covered by this warranty?**

This warranty does not apply: (i) to damage caused by use with products not manufactured by Emotiva, where the non-Emotiva product is the cause of the damage; (ii) to damage caused by service or maintenance performed by anyone who is not a representative of Emotiva; (iii) to damage caused by accident, abuse, misuse, flood, fire, earthquake or other external causes; (iv) to a product or part that has been modified after its retail purchase, where the modification caused or contributed to the damage; (v) to consumable parts, such as batteries or failure of or damage to the Product caused by batteries; (vi) if any Emotiva serial number has been removed or defaced on the product; (vii) glass or plastic panels, cabinetry, trim or other appearance items; (viii) cosmetic wear or damage to remote controls by user.

EMOTIVA SHALL NOT BE LIABLE FOR ANY INCIDENTAL OR CONSEQUENTIAL DAMAGES ARISING FROM OR RELATED TO ANY DEFECTS IN OR DAMAGES TO ITS PRODUCTS. SOME STATES DO NOT ALLOW THE EXCLUSION OR LIMITATION OF INCIDENTAL OR CONSEQUENTIAL DAMAGES, SO THE ABOVE LIMITATION OR EXCLUSION MAY NOT APPLY TO YOU.

## **How do you get service?**

In order to make a claim under the Warranty, you must:

1. Call or e-mail a customer service representative at 1-877-EMO-TECH (1-877-366-8324) or support@emotiva.com. You must provide a description of your problem, the serial number of the Product for which the warranty claim is being made, and the original purchase date.
2. Then, you will be provided with a warranty service authorization number ("WS").
3. Next, you must ship the Product to the following address, with the WS written in large, bold numbers on the outside of the box, and with the letters "WS" written before the number, for example: WS1234. Parcels arriving without a WS number on the outside of the box will be refused. The customer pays for the shipping to Warrantor. Warrantor pays for the shipping back to the customer within the continental United States only. Customer is responsible for shipping charges on all other warranty claims.

**Emotiva Audio Corporation  
Attn: Repair Department  
139 Southeast Parkway Court  
Franklin, TN 37064**

# BASX A2 / A2mini / A3 / A4 / A5 / A7

---

Units will be refused by Emotiva for the following:

Product was sent without the WS#

Product was sent with inadequate packaging.

Product was damaged in transit.

Product was shipped collect for shipping charges.

## **How does state law apply?**

This warranty gives you specific legal rights, and you may also have other rights which vary from state to state.

## **What if my product is damaged on the way to you?**

Emotiva is not liable for damages that may incur while an item is in transport to us. Please purchase insurance when you ship your item. If your Product was not adequately packaged, we will refuse receipt and the damaged package will be returned to you at your cost. If you do not have the original Emotiva Audio packaging, please check with our sales department to purchase replacement-shipping cartons.

## **How does the Warranty and service apply to international orders?**

The Product Warranty is only valid in the country where the Emotiva product was originally shipped via an authorized dealer, distributor, or direct from the Emotiva factory. The Warranty is subject to change at any time depending on the laws and regulations within your specific country. Please check with your distributor for a complete understanding of the warranty in your county.

If you purchased your Emotiva Product outside of the USA and wish to have it serviced at the factory, all freight charges are your responsibility. If you do not have an authorized distributor or repair center in your country, your Product must come back to the Emotiva USA factory for warranty service.

## Notes

---

---

---

---

---

---

---

---

---

---

All information contained in this manual is accurate to the best of our knowledge at the time of publication. In keeping with our policy of ongoing product improvement, we reserve the right to make changes to the design and features of our products without prior notice.



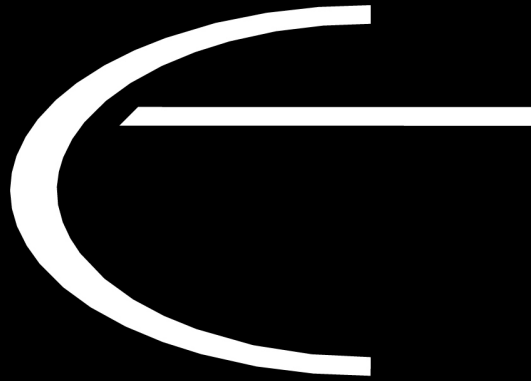

Emotiva Audio Corporation  
135 Southeast Parkway Court  
Franklin, TN 37064

[www.emotiva.com](http://www.emotiva.com)