

LYRIC | STREAMING AUDIO SYSTEM

USER GUIDE

Made for
 iPod  iPhone  iPad

Contents

Important! Read before operating this equipment!	1	Music libraries	7
Power supply:	2	Setting up a network music library	7
Servicing:.....	2	Choosing a file format for your library	7
Radio frequency disturbance:.....	2	Mixing formats	7
Laser product	2	Buying music online	7
Product service centres:	2	Further advice on setting up a library	7
Legal notices	3	Lyric music library configurations.....	8
Introduction	4	USB music storage	8
Unpacking	4	Advantages	8
Positioning Lyric	4	Disadvantages	8
Before first use.....	4	Ethernet system with NAS drive	9
Front panel connections	4	Advantages	9
Opening the cover	4	Disadvantages	9
The versatility of Lyric	5	All-wireless system.....	10
Music streaming	5	Advantages	10
Internet radio	5	Disadvantages	10
USB ports.....	5		
Bluetooth wireless technology.....	5		
Built-in CD transport.....	5		
Radio tuner.....	5		
External digital sources	5		
External analogue sources.....	5		
Built-in amplifier.....	5		
Secondary preamplifier output	5		
Controlling Lyric	5		
Interactive display	5		
Remote control.....	5		
Front panel controls	5		
Cadence app.....	5		
Speaker setup advice	6		
Larger, floor standing speakers.....	6		
Compact speakers	6		
Changing speaker and tone control settings	6		

Contents

Connections	11	Controlling Lyric	16
Connecting to Lyric	12	Front panel.....	16
Caution! Before connecting any cables	12	Remote control	17
Connecting to a computer network	12	introduction.....	17
Wired ethernet connection	12	Remote control backlight	17
802.11g wireless aerial	12	Fitting batteries to the remote control.....	17
Connecting a radio aerial	12	Battery replacement.....	17
Indoor aerial	12	Battery disposal	17
Outdoor aerial	12	Remote control commands.....	18
Connecting digital audio sources	13	Learning TV and satellite commands	19
Compatible sources	13	Preparation for learning	19
Connecting a digital source	13	Learning commands	19
Connecting an analogue audio source.....	13	Checking programmed commands.....	20
Compatible sources	13	Problems with learning	20
Connecting an analogue source	13	Sending TV or SAT commands.....	20
USB A 'docking' ports.....	14		
USB A compatible devices	14		
Connection options	14		
USB B laptop port	14		
Connecting to the Laptop USB B port.....	14		
mini-USB upgrade port	14		
Connecting to loudspeakers.....	15		
Speaker cables.....	15		
Speaker cable polarity	15		
Connecting the cables to Lyric.....	15		
Connecting the cables to your speakers.....	15		
Analogue output	15		
Fixed or variable level analogue output	15		
Connecting to the analogue output	15		
Connecting a subwoofer	15		
Subwoofer cables	15		
Connecting Lyric to a subwoofer	15		
Connecting headphones	15		
Connecting to the AC mains supply	15		

Contents

Operation	21	Selecting DAB or FM radio	26
Front panel controls	21	Select DAB/FM operation	26
Remote control.....	21	Changing between DAB and FM bands	26
Menu navigation.....	21	Listening to DAB radio.....	26
Alphanumeric character entry.....	21	First time use	26
Power	22	Station list.....	26
To switch Lyric on from standby	22	Selecting a station	26
In regular use.....	22	Returning to the station list.....	26
First use	22	DAB options menu	27
To set Lyric to standby when operational.....	22	Opening the DAB options menu.....	27
Standby modes.....	22	Station List	27
Display backlight	22	Local Scan	27
Proximity sensor	22	Full Scan.....	27
Manual control of the backlight	22	DRC.....	27
Selecting a source	23	Station Order	27
Direct access from the remote control.....	23	Prune station	27
From the source menu	23	Main Menu.....	27
Volume control	23	Listening to FM radio	28
To increase the volume	23	FM scan tuning	28
To decrease the volume	23	FM step tuning	28
Balance control	24	FM options menu.....	28
Mute	24	Opening the FM options menu	28
Playing a CD	25	Scan setting	28
Selecting CD operation	25	Audio setting	28
Loading a disc.....	25	Main menu	28
Ejecting a disc.....	25	Re-setting the radio.....	28
Playing a disc	25	To reset the radio	28
Pausing	25		
Next/previous track selection	25		
Skip to a track number	25		
Fast forward/reverse search.....	25		
Repeat	25		
Shuffle	25		
Stopping play.....	25		

Contents

Playing Aux sources.....	29	Playing TuneIn (Internet) radio	34
To select an Aux source	29	Browsing stations	34
Playing a digital Aux source.....	29	Favourite station presets.....	34
Playing an iPod/iPhone/iPad.....	29	Registering Lyric with TuneIn.....	34
Playing other USB sources	29	To register your Lyric at TuneIn.....	34
Playback control	29	Saving and recalling internet radio presets	34
Playing a computer or laptop.....	30	Playing a Bluetooth source	35
Playing an analogue Aux source	30	Selecting the Bluetooth source	35
Streaming music from a network.....	31	Pairing with a Bluetooth source	35
Selecting network streaming.....	31	Re-connecting.....	35
In regular use.....	31	Playing music.....	35
First time use with a cabled network	31	Cadence	36
First time use with a wireless network.....	31		
If no network is found	31		
Select a network music server.....	32		
Browsing for music	32		
Playing music.....	32		
Browsing for a new selection	32		
Pausing	32		
Next/previous track selection	32		
Fast forward/reverse search.....	32		
Stopping play.....	32		
Favourite tracks.....	33		
To save a track to your favourites.....	33		
To play your favourite tracks	33		
To delete a track from your favourites	33		

Contents

Setting up Lyric	37	Setup > Balance	43
The Setup menu	37	Setup > CD play mode	43
Navigating the Setup menu	37	Changing the Autoplay setting	43
To step back through the Setup menu	37	Setup > Backlight	43
To exit the Setup menu	37	Changing display backlight settings	43
Setup > Network	38	Setup > Proximity sensor	43
Setup > Network > Wired	38	Proximity sensor settings	43
DHCP automatic IP address assignment (DHCP ON)	38	Changing proximity sensor settings	43
Assigning a fixed IP address (DHCP OFF)	38	Auto switch display	43
Setup > Network > Wireless	39	Setup > Standby	43
Setup > Network > Status	39	Changing the Low power standby setting	43
Setup > Equaliser	40	Setup > Unit name	44
Enabling/disabling the equaliser	40	To display the name	44
Changing equaliser settings	40	To exit without changing the name	44
Setup > Aux input names	40	To change the name	44
Default input naming	40	Setup > About	44
Changing Aux input names	40	Setup > Factory reset	44
Setup > Speaker config	41	To reset Lyric	44
Choosing a speaker configuration	41		
2.0 channel settings	41		
2.0 channel > Primary output settings	41		
2.0 channel > Secondary output settings	41		
2.1 channel speaker settings	42		
2.1 channel speaker settings > High and low pass	42		
2.1 channel speaker settings > Gain (sub)	42		

Contents

Trouble-shooting	45	Firmware upgrades	49
No power	45	Checking the current firmware version	49
No backlight	45	Upgrading the firmware	49
No sound at all	45	Specifications	50
No sound from a digital input	45	Lyric Features	50
No remote control operation	45	Connectivity	50
Remote control flashing	45	Network streaming	50
CD not loading	45	Internet radio	50
CD not playing	45	Radio tuner	50
No DAB radio stations	45	Lyric Performance	50
Noisy FM reception	45	Outputs	50
USB drive navigation problems	45	Digital inputs	50
Fault indications	46	Analogue input	50
DC offset fault	46	Tuner	50
Over current fault	46	USB drive	50
PSU Service	46	Warranty	51
Temperature error	46	Disposal	51
Network trouble-shooting	47		
Unable to join a network	47		
Wireless network is not visible	47		
Intermittent playback from a network	47		
UPnP server trouble-shooting	48		
UPnP music server not found	48		
Internet radio trouble-shooting	48		

Important! Read before operating this equipment!

Caution: The exclamation mark is to draw your attention to important instructions and safety procedures in this manual.



Attention: The lightning flash warns you of the risk of electrical shock presented by components inside this product. Unauthorised personnel must not open this unit.



Warning: To reduce the risk of electrical shock do not remove any unit covers or panels. There are no user serviceable parts in this product.

Warning: To reduce the risk of electric shock, do not expose this equipment to rain or moisture.

Heed warnings: All warnings on the product and in the operating instructions should be adhered to.

Read all the instructions: All the safety and operating instructions should be read before the product is operated.

Retain instructions: The safety and operating instructions should be retained for future reference.

Follow instructions: All operating and use instructions should be followed.

Cleaning: Unplug this product from the mains before cleaning. Do not use liquid or aerosol cleaners. Use a damp cloth for cleaning.

Water and moisture: Do not use this product near water - for example, near a bath tub, wash bowl, kitchen sink, or laundry tub, in a wet basement; or near a swimming pool and the like. The product must not be exposed to dripping or splashing and no objects filled with liquids, such as vases, shall be placed on the product.

Heat: The product should be situated away from heat sources such as radiators, stoves, or any other products (including amplifiers) that produce heat.

Ventilation: Slots and openings in the cabinet are provided for ventilation, to ensure reliable operation of the product and to protect it from overheating and these openings must not be blocked or covered. The openings should never be blocked by placing the product on a bed, sofa, rug or similar surface. This product should not be placed in a built-in installation such as a bookcase or rack unless proper ventilation is provided or the manufacturer's instructions have been adhered to.

Object or liquid entry: Never push objects of any kind into this product through openings as they may touch dangerous voltage points or short-out parts that could result in a fire or electric shock.

Accessories: Do not place this product on an unstable cart, stand, tripod, bracket, or table. The product may fall, causing serious injury to a child or adult, and serious damage to the product. Use only with a cart, stand, tripod, bracket or table recommended by the manufacturer, or sold with the product. Any mounting of the product should follow the manufacturer's instructions, and should use a mounting accessory recommended by the manufacturer.

Attachments: Do not use attachments not recommended by the product manufacturer as they may cause hazards.

Moving the product: A product and cart combination should be moved with care. Sudden stops, excessive force, and uneven surfaces may cause the product and cart to overturn.



Power sources: This product should be operated only from the type of power source indicated on the marking label. If you are not sure of the type of power supply to your home, consult your product retailer or local power company. For products intended to operate from battery power, or other sources, refer to the operating instructions.

Overloading: Never overload wall outlets, extension cords, or integral convenience receptacles. This can result in an increased risk of fire or electric shock.

Power cord protection: Power supply cords should be routed so that they are not likely to be walked on or pinched by items placed upon or against them, paying particular attention to cords at plugs, convenience receptacles, and the point where they exit from the product.

Naked flames: No naked flame sources, such as candles, must be placed on this product.

Lightning: For added protection for this product during a lightning storm, or when it is left unattended or unused for long periods of time, unplug it from the wall outlet and disconnect the antenna or cable system. This will prevent damage to the product due to lightning and power-line surges.

Batteries: Batteries shall not be exposed to excessive heat such as sunshine, fire or the like.

Caution! Polarised connector (Canada and the USA): To prevent electrical shock, match wide blade of plug to wide slot, fully insert. Do not alter or remove this plug if it does not fit your mains power socket. Have a suitable socket installed by a competent electrician.

Access to the mains plug: The means to disconnect this product from the mains supply is the mains plug. Ensure that the mains plug is accessible at all times.

Power supply:

The mains supply requirement for your Cyrus **Lyric** is marked on a label on the rear panel. Before connecting, check that this voltage is the same as your mains supply.

230V Products: Voltage Range 220V-230V

115V Products: Voltage Range 110V-120V

If you move to an area with a different mains voltage, contact your local Cyrus distributor to have your product converted.

There are no user replaceable fuses in this unit.

Servicing:

Do not attempt to service this product yourself as opening or removing covers may expose you to dangerous voltage or other hazards. Refer all servicing to qualified service personnel.

Conditions requiring service: Unplug this product from the wall outlet and refer servicing to qualified service personnel when:

- When the power supply cord or plug is damaged.
- If liquid has been spilled, or objects have fallen into the product.
- If the product has been exposed to rain or water.
- If the product has been dropped or damaged in any way.
- If the product does not operate normally by following the operating instructions. (Adjust only those controls that are covered by the operating instructions. Improper adjustment of other controls may result in damage requiring extensive work by a qualified technician to restore the product to its normal operation).
- When the product exhibits a distinct change in performance.

Replacement parts: When replacement parts are required, be sure the service technician has used replacements specified by the manufacturer or have the same characteristics as the original part. Unauthorised substitutions may result in fire, electric shock, or other hazards.

Safety check: Upon completion of any service or repairs to this product, ask the service technician to perform safety checks to determine that the product is in proper operating condition.

Radio frequency disturbance:

This equipment generates, uses and can radiate radio frequency energy and, if not installed and used in accordance with the instructions, may cause harmful interference to radio communication. However, this is no guarantee that interference will not occur in a particular installation. If this equipment does cause harmful interference to radio or television reception, which can be determined by turning the equipment off and on, the user is encouraged to try to correct the interference by one of the following measures:

- Reorient or relocate the receiving antenna.
- Increase the separation between the equipment and receiver.
- Connect the equipment into an outlet on a circuit different from that to which the receiver is connected.
- Consult the retailer or an experienced radio/TV technician for help.

Laser product



This label on the rear panel tells you that the unit contains a Laser component. Opening this unit will expose the user to radiation from the laser beam.

Product service centres:

For product service or technical advice, contact only authorised Cyrus service centres. Contact details for Cyrus distributors may be found on the Cyrus website at www.cyrusaudio.com.

Legal notices

“Made for iPod,” “Made for iPhone,” and “Made for iPad” mean that an electronic accessory has been designed to connect specifically to iPod, iPhone, or iPad, respectively, and has been certified by the developer to meet Apple performance standards. Apple is not responsible for the operation of this device or its compliance with safety and regulatory standards. Please note that the use of this accessory with iPod, iPhone, or iPad may affect wireless performance.

iPad, iPhone and iPod touch are trademarks of Apple inc., registered in the U.S. and other countries.

The **Bluetooth**[®] word mark and logos are registered trademarks owned by **Bluetooth** SIG, Inc. and any use of such marks by Cyrus is under license. Other trademarks and trade names are those of their respective owners.

Introduction

Congratulations on your choice of Cyrus hi-fi products. Our state-of-the-art design technology and outstanding quality of manufacture has won countless awards around the world. We are confident that you will derive great pleasure from owning a product from one of the most recognised and respected manufacturers of hi-fi equipment.

Now is a good time to register your new Cyrus product. Registration takes only a few minutes, brings the added benefit of a full two year factory warranty and adds you to our mailing list for future product updates and upgrades. To register, visit www.cyrusaudio.com and click the 'Login/Register' link.

Please read these instructions carefully before commencing installation. They provide full guidance to help you install your **Lyric** safely and correctly.

If you have any questions about this product, its installation or its operation, please contact your retailer, the best local source of information.

Unpacking

Before installing **Lyric**, check that the carton includes the following items:

- Cyrus **Lyric**
- Remote control with batteries.
- UK power cable.
- Europlug power cable for use in other European markets.
- Wi-Fi aerial
- DAB/FM aerial.
- 1m Ethernet cable
- mini-USB firmware upgrade cable.
- Handbook CD-ROM

After removing these items, please retain the gift box, shipping box and any internal packaging. **Lyric** must always be re-packed in this original packaging when shipped to protect against any damage.

Positioning Lyric

Lyric should be installed in a well ventilated location, away from sources of high temperature, dust or humidity.

Never stand the unit under another unit or on any surface likely to obstruct its cooling or ventilation.

Before first use

Protective film may be fitted to some cosmetic surfaces of **Lyric** when new.

These protective films should be peeled off carefully before use.

Front panel connections

Two connections are placed on the front panel for convenient access. These are-

- Front USB port.
- Headphone socket.

These connections are hidden behind a protective cover at the right end of the front panel.

Opening the cover

- Lift the right edge of the cover and it will unclip from the front panel to reveal the connections.
- Press the cover gently back into place to cover the connections when not required.

NOTE: There are no connections beneath the cover at the left side of the front panel so the cover is not removable.

The versatility of Lyric

Music streaming

Wired and wireless connectivity for a computer network enable music streaming from shared music libraries located anywhere on your local network.

Internet radio

Through your computer network, Internet radio gives you access to thousands of radio stations around the globe.

USB ports

Convenient USB ports allow you to dock and play music from your iPod, iPhone or iPad, to connect a hard-drive music library or to dock a USB flash drive or personal audio player containing music files.

Bluetooth wireless technology

Bluetooth wireless technology enables music streaming from your mobile phone, **Bluetooth** equipped laptop or other wireless devices.

Built-in CD transport

Lyric includes a CD transport based on the renowned Cyrus CD technology developed for Cyrus component audio.

Radio tuner

A radio tuner to play local DAB or FM radio broadcasts off-air.

External digital sources

Lyric also includes connectivity for digital sources you may own including Blu-ray and DVD players, satellite receivers and games consoles.

External analogue sources

Analogue sources such as tape players and even a turntable (will require an external preamplifier) may be connected to the analogue input.

Built-in amplifier

No external power amplifier is required. The built-in amplifier is a Cyrus design, specifically for **Lyric**, with a huge reserve of power provided by a vast linear power supply.

Secondary preamplifier output

The secondary preamplifier output is menu configurable as a fixed analogue output for a tape recorder or as a variable output for a power amplifier or subwoofer.

Controlling Lyric

Interactive display

The front panel includes a full-colour graphic display screen. The display switches according to your requirements, showing large format characters for volume setting, menu lists for option selections and will display full colour album art and logos for Internet radio stations*.

* Where available.

Remote control

The remote control supplied with **Lyric** operates all **Lyric** functions from your listening chair. In addition, the remote control may be programmed with two further command sets, usually for your TV and for a satellite receiver.

Front panel controls

The front panel includes back-lit controls that can control **Lyric** via the interactive menus. The brightness of the display and controls may be set to your requirement or switched off completely, activating briefly when a command is sent.

Cadence app

The **Cadence** app is available for compatible Apple and Android devices. **Cadence** provides a fully graphic interactive interface from the convenience of your portable device. **Cadence** is a free download from the iTunes Store or Google Play Store.

Speaker setup advice

Lyric has been engineered to maximise performance with a wide range of loudspeaker types and placement options. When you start-up **Lyric**, it automatically assesses your speakers in a fraction of a second and realigns the amplifier to match the terminal impedance of your speakers (this we call Speaker Impedance Detection or SID).

Cyrus predicted that **Lyric** will be used with larger speakers, but there is no reason why you cannot use **Lyric** with high performance compact speakers. All **Lyric** models are fitted with superb DSP tone controls that enable tonal adjustments that audiophiles would have rejected in the past to be enjoyed without degrading the sound.

Whatever your chosen speaker setup, SID and the extremely advanced DSP tone controls will enable integration with any speaker type.

Larger, floor standing speakers

Some owners will choose to partner **Lyric** with a set of high performance floor standing speakers costing many thousands of pounds, providing astonishing audio quality, scale and dynamics.

Out of the box **Lyric** is set to partner traditional floor standing speakers. The default Speaker Config setting is therefore 2.0 channels. (Two speakers and no subwoofer).

The DSP tone controls are factory set to apply no correction.

Compact speakers

Many owners will select high quality compact speakers that **Lyric** can drive to sound far more capable than their smaller boxes suggest. If you have chosen compact speakers, possibly mounted on shelves and partnered with a compact sub bass speaker, **Lyric** can be set up to maximise the performance of your system.

If your **Lyric** system includes compact speakers with a subwoofer you will need to change the default speaker settings to 2.1 channels to activate the subwoofer and apply a crossover between the speakers and subwoofer.

Changing speaker and tone control settings

To change the channel settings, crossover settings or subwoofer gain, refer to the Setup > Speaker config section.

To experiment with tone controls and shape the response to best match your room, refer to the Setup > Equaliser section.

Music libraries

This section includes some background information and advice from Cyrus about digital music libraries.

If you plan to set up a music library or use an existing library with **Lyric**, this section will help you to get the best results from your library.

If you are not planning to link **Lyric** to a music library at this stage, you can skip this section.

Audiophile systems have progressed over the years from shelves of fragile vinyl records or magnetic tape to racks of compact discs, played without any physical contact.

Perfect sound forever? Perhaps, but for a serious audiophile an extensive collection of CDs still occupies a large space in a room, usually in the listening room itself. Cataloguing the CDs can be a chore and remembering which album your favourite tracks are on can be quite a challenge in a large collection of CDs.

Lyric answers all of these problems, by using computer hardware to take the music content from your discs and store the entire collection in a music library on a networked hard-drive (NAS) that occupies little more space than a few CDs.

Setting up a network music library

Choosing a file format for your library

Hard-drive size was once a limitation for storage of a high quality, uncompressed music library. This is no longer the case as high capacity hard-drives are now affordable, and multiple drives are also an option.

Lossless formats are also now available, offering the quality of uncompressed files, but with a useful saving of around 40% of the file size.

If you already have an existing library of uncompressed WAV or AIFF files ripped from CD, then this will deliver the highest quality when played through **Lyric**.

If you have an existing library that includes MP3, WMA, AAC or other compressed format files, you may want to consider creating a new library of uncompressed or lossless files from your CD collection. Although **Lyric** is compatible with compressed files, the compression used by these formats to pack the files into a small space removes essential information from the music that cannot be replaced on replay.

The same recommendation applies if you are setting up a new music library for use with **Lyric**. In a new library, uncompressed files carry the highest recommendation.

Mixing formats

Lyric will decode most music file types, so it is quite acceptable to retain an existing library of compressed format files, rip new music entries to uncompressed or lossless files and replace the compressed files as time permits.

Lyric can also browse multiple libraries, so you may prefer to retain a library of compressed files for portable audio etc., and set up a new library of uncompressed or lossless music just for **Lyric**.

Buying music online

There are currently few sources online for the purchase of high quality uncompressed or lossless files. To achieve the best quality for your music library, rip your music from CD to uncompressed or lossless files.

Further advice on setting up a library

A good retailer can advise on setting up a library of music files for use with **Lyric**.

Lyric music library configurations

Lyric is extremely versatile and can be incorporated into your music world in many different ways. This section shows two configurations recommended by Cyrus, and one that is not recommended.

The systems are illustrated as guidelines only to help you plan the best way to install **Lyric**.

Your retailer will have been trained to provide you expert advice to find the optimum setup for your **Lyric** system.

USB music storage

Recommended!

This is the simplest system and recommended if you would like to set up a music library, but don't have access to a computer network.

Advantages

- Extremely simple to set up.
- Does not require a network or a computer to function.

Disadvantages

- Library navigation is by folder on the hard drive.
- The hard drive must be re-connected to a computer when you want to add music to the library.
- With no connection to the internet, internet radio reception is not possible.

NOTE: A hard drive connected via the USB port must be formatted as FAT16 or FAT32 only.

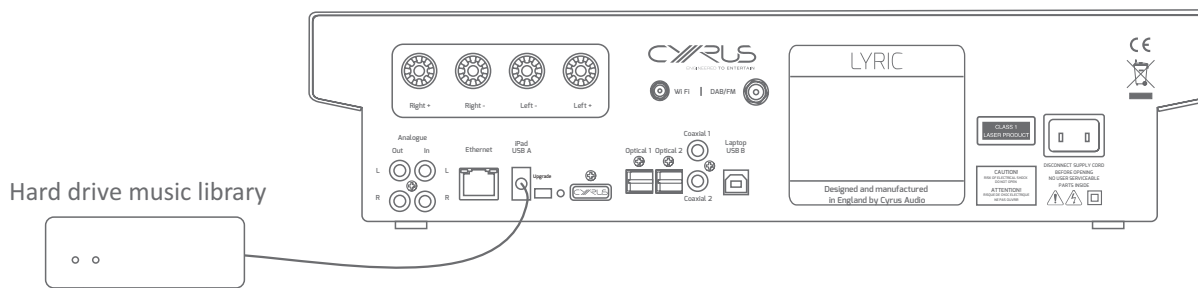

Ethernet system with NAS drive

Recommended!

This is the optimal **Lyric** system. In this system all network connections are cabled and the music library is contained on a NAS drive, located close to **Lyric**. The network switch, placed near **Lyric**, provides local connection between **Lyric** and the NAS drive for fastest possible data transfer. The network switch links to the router to enable Internet Radio functions and music transfer between the computer and the NAS drive.

This system carries the strongest recommendation from Cyrus.

Advantages

- Robust wired connection between network components.
- Easy navigation of music content.
- Music is added to the library on the NAS drive from the computer through the network.
- Internet radio reception is possible.

Disadvantages

- None.

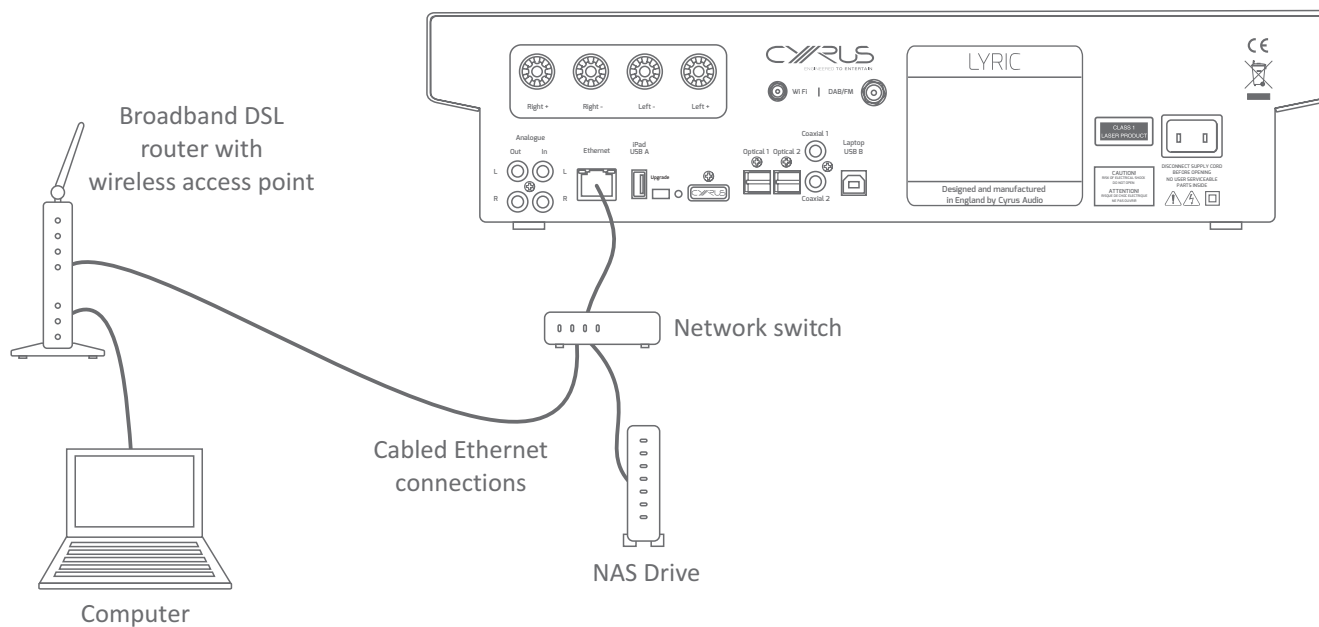

All-wireless system

Not recommended!

Although Cyrus Wi-fi technology can provide a really easy installation solution, wireless transfer can be affected by the building and other Wi-fi equipment, Therefore, where possible, a wired installation is recommended for the best transfer of large files.

Advantages

- Looks simple to install.

Disadvantages

- Lower quality connection between networked components.
- Installation and configuration of UPnP server software on each network computer will be necessary to permit access to the music library.
- Music is only available to **Lyric** when the computer(s) containing the music library is switched on.

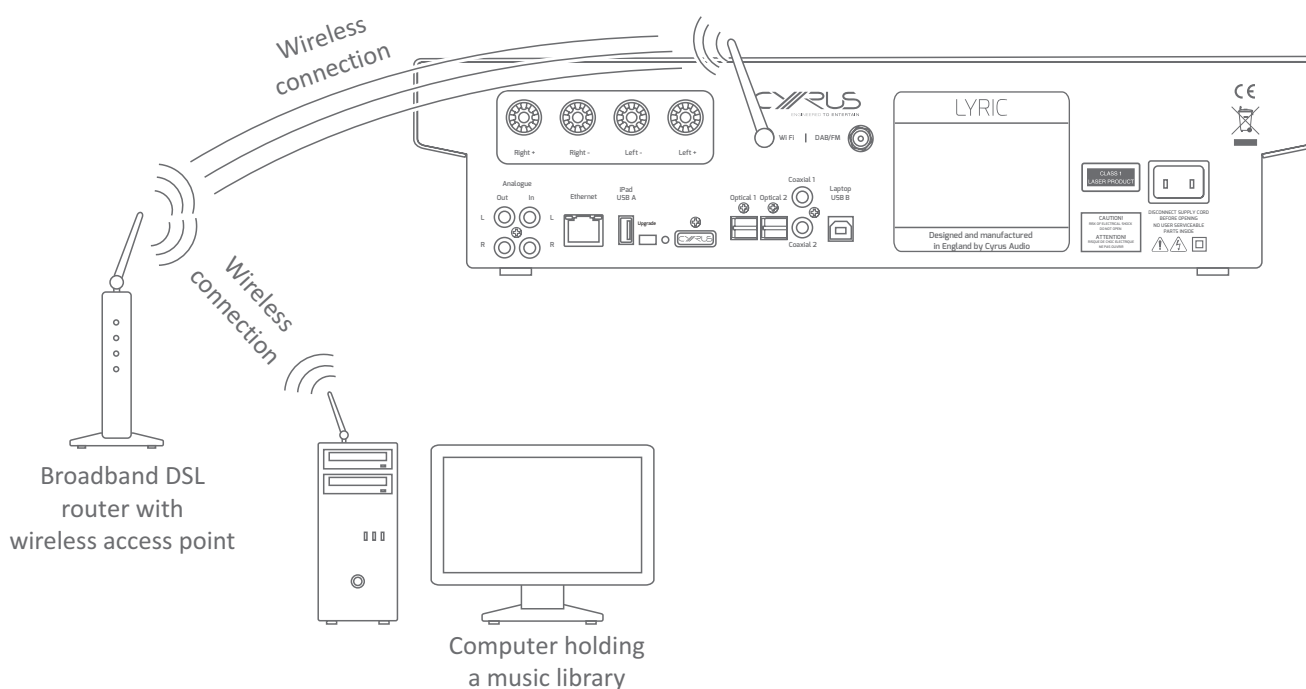

Connections

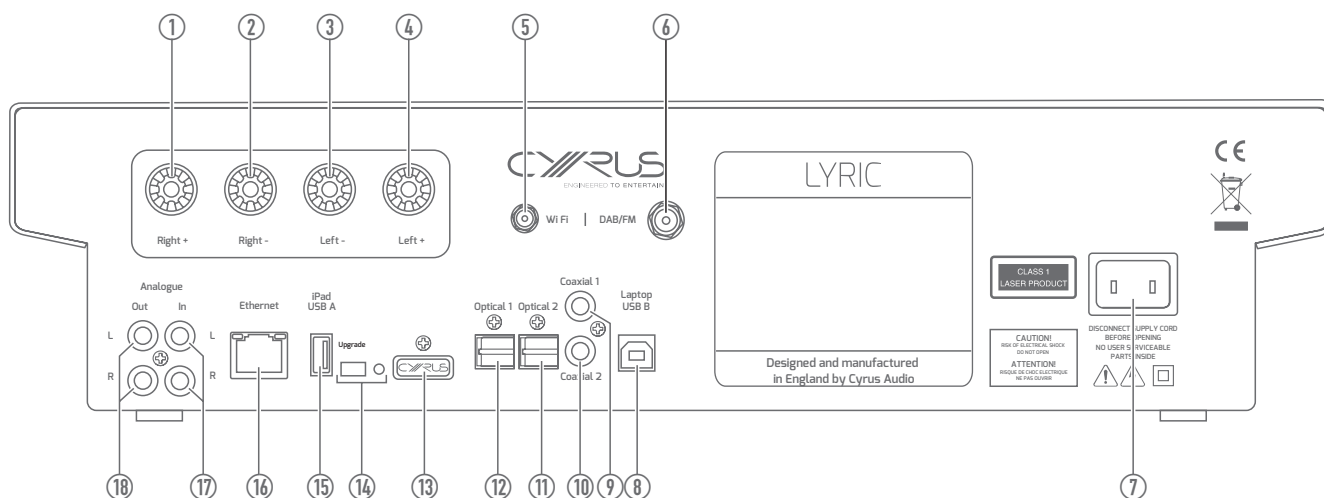

- 1. Right speaker terminal +
- 2. Right speaker terminal -
- 3. Left speaker terminal -
- 4. Left speaker terminal +
- 5. Wi-fi aerial
- 6. DAB/FM aerial
- 7. AC Mains inlet
- 8. USB B port
- 9. Coaxial 1 digital input
- 10. Coaxial 2 digital input
- 11. Optical 2 digital input
- 12. Optical 1 digital input
- 13. **Bluetooth** and remote aerials
- 14. Upgrade switch and port
- 15. USB A port compatible with iPad and charging
- 16. Ethernet network connector
- 17. Stereo analogue in connectors
- 18. Stereo analogue out connectors

Connecting to Lyric

Caution! Before connecting any cables

To avoid possible damage to **Lyric**, it is essential to disconnect **Lyric** and all its sources from the mains supply when making or changing any signal connections.

Always finish connecting up the signal cables, then connect the mains supplies.

Connecting to a computer network

Connection to a computer network which has internet access will be necessary if you want to stream music via your network or to listen to internet radio.

There are two network connection options, wired ethernet cable connection or 802.11g wireless. If **Lyric** detects a wired connection, this will be used in preference to a wireless connection.

Wired connection is strongly recommended as this enables a far higher data bandwidth than wireless connection.

Wired ethernet connection

Lyric is supplied with a 1m length ethernet cable. If this cable is not suitable for your installation, pre-assembled ethernet cables of the correct length are readily available. Measure the distance that the cable will run between **Lyric** and a spare connection on the router/switch, or if the building is pre-wired with ethernet cable, to the nearest ethernet socket on the wall. Obtain an ethernet cable of at least this length.

- Plug the cable into the ethernet socket ④ on the back panel.

The plug will latch into place.

- Connect the other end of the cable to the modem/router or wall socket.

NOTE: Ethernet wired connection is very robust and will run over distances of 50m or more without requiring a repeater.

802.11g wireless aerial

If you are connecting **Lyric** to a network via 802.11g wireless, you will need to fit the wireless aerial.

- Screw the aerial directly onto the Wi-fi aerial connector ⑤ on the back panel.

The aerial should be aligned vertically for best results.

Connecting a radio aerial

Indoor aerial

- Screw the telescopic aerial (supplied) directly to the DAB/FM aerial socket ④.
- Extend the aerial fully.

If radio broadcasts are noisy or intermittent, signal strength may be marginal and an outdoor aerial will be necessary.

Outdoor aerial

For best radio reception, an outdoor aerial is always recommended.

Your local aerial installer will check the signal strength available and supply the correct aerial for your area. A TV aerial will not be suitable. The cable must be terminated with the correct 'F-type' connector.

Connecting digital audio sources

Compatible sources

The digital audio inputs are compatible with a number of different digital audio sources. These include-

- Digital audio output from a CD transport
- Blu-ray/DVD players (for replay of 2 channel PCM programs only)
- Digital output from satellite receivers (for replay of 2 channel PCM programs only)
- Games console

Connecting a digital source

- Using a suitable Toslink optical or a digital phono interconnect, connect each digital audio source to one of the optical or coaxial inputs ⑨ - ⑫.

Make a note of the input number used for each source as the inputs can be re-named to match your source at the set-up stage.

Connecting an analogue audio source

Compatible sources

The analogue input is available for the connection of stereo analogue audio sources including -

- Analogue output from CD/DVD Players
- Analogue output from DAB or FM Radio tuners
- Phono pre-amplifier for a turntable
- Televisions
- Analogue output from Satellite Receivers
- Analogue tape/disc recorders

Connecting an analogue source

- Connect a stereo audio interconnect between the analogue source and the Analogue In sockets ⑬ on the rear panel.

The white (left) and red (right) coloured plugs help you ensure the left and right channels are correctly connected at each end.

The analogue input can be re-named to match your source at the setup stage.

USB A 'docking' ports

There are two USB A ports for docking of compatible Apple devices or for connection of a USB flash drive, hard drive or personal audio player.

USB A compatible devices

Lyric is compatible with the following Apple devices:

- iPad 2
- iPad (3rd generation)
- iPad (4th generation)
- iPad mini
- iPhone 5s
- iPhone 5c
- iPhone 5
- iPhone 4s
- iPhone 4
- iPod touch 5th gen
- iPod touch 4th gen
- iPod touch 3rd gen

Other Apple devices are not compatible.

Also

- USB flash drives, personal audio players or hard drives containing music files (FAT16, FAT32 formats only).

NOTE: In the operational text of this handbook, the term 'iPad' refers to all compatible Apple devices.

Connection options

There are two connections available for compatible devices, a front panel USB port (behind the protective cover at the right end of the front panel) and a back panel USB port [Ⓜ] marked iPad USB A.

- Connect a compatible device to either port. Apple devices may be connected via the USB cable supplied by Apple.

NOTE: Devices may be docked to both ports simultaneously if required, but if two Apple devices are docked, only the last device selected will charge.

USB B laptop port

You can connect your computer or laptop to **Lyric** to replay music, movie soundtrack or other sounds stored on your computer.

Connecting to the Laptop USB B port

- Connect a standard USB cable between a free USB port of your computer and the 'Laptop USB B' port [Ⓜ] on the back panel of **Lyric**.

mini-USB upgrade port

The mini-USB upgrade port [Ⓜ] is provided for connection to a PC to enable firmware upgrades.

For more information about upgrading the firmware in **Lyric**, refer to the Firmware upgrade section.

Connecting to loudspeakers

Speaker cables

Ensure you allow adequate length for the cables to be routed where they will not become a trip hazard. Where possible, keep left and right cables to the same length. Spade terminations are recommended for best performance.

A Cyrus audio retailer will recommend the best speaker cable to partner **Lyric**, and terminate the cables to match **Lyric** and the speakers you own.

CAUTION: The speaker outlets are only suitable for connection directly to speakers. Never connect any switch-box or other device to the speaker outlets.

Speaker cable polarity

Speaker cables will always include polarising marks such as a rib or stripe to indicate the '+' wire and red/black identifiers on the terminals. Ensure you connect the red terminal/striped cable to the + terminals on **Lyric**.

Connecting the cables to Lyric

- Unscrew the knobs on the four speaker terminals ① - ④.
- If the cable terminations are bare-wire stranded, twist the cables before fitting them to the terminals.
- Fit each spade terminal under the knob of the correct terminal. Bare wire terminations may be passed through the cross-hole. Check that there are no loose wire strands.
- Tighten the knob securely.
- Repeat these steps for the other terminals.
- Check carefully that channel and cable polarities are correct.

Connecting the cables to your speakers.

- Refer to the speaker instructions for cable connection.

Analogue output

Fixed or variable level analogue output

The analogue output is supplied set with a variable output that tracks the main volume control. This is suitable for connection to subwoofers or power amplifiers.

Through the 'Speaker config' section of the Setup menu, this output can also be set to a fixed level output. This will be required for a recording feed to a tape recorder or other analogue recording device.

Connecting to the analogue output

- Connect a stereo interconnect between the analogue output ⑧ and the input of the tape recorder or amplifier.

Connecting a subwoofer

Subwoofer cables

You will need a connecting cable that is long enough to run from the **Lyric** to the subwoofer. Ensure that the cable is fully shielded (for subwoofer use) and that the terminations are phono plugs. Both channels provide the same mono subwoofer signal when set for 2.1 channel operation so stereo or mono cables may be used depending on the requirements of the subwoofer.

Connecting Lyric to a subwoofer

- Connect the interconnect between the left and/or right channel (R) Analogue output ⑩ and the LFE socket(s) of the subwoofer.

Connecting headphones

Headphones may be connected to **Lyric** for personal listening.

Warning: Excessive sound pressure from earphones and headphones can cause hearing loss.

- Open the front panel connection cover and plug in the headphones.

When headphones are connected the system speakers will automatically mute.

Connecting to the AC mains supply

Connect the socket on the AC Power cable to the power inlet ① on the rear panel of the unit. Now connect the cable to a suitable AC power point.

There is no mains power switch on **Lyric**. To switch off the mains supply to **Lyric** remove the plug from the wall outlet. For this reason, ensure that the plug is easily accessible when installing the unit.

Controlling Lyric

Front panel

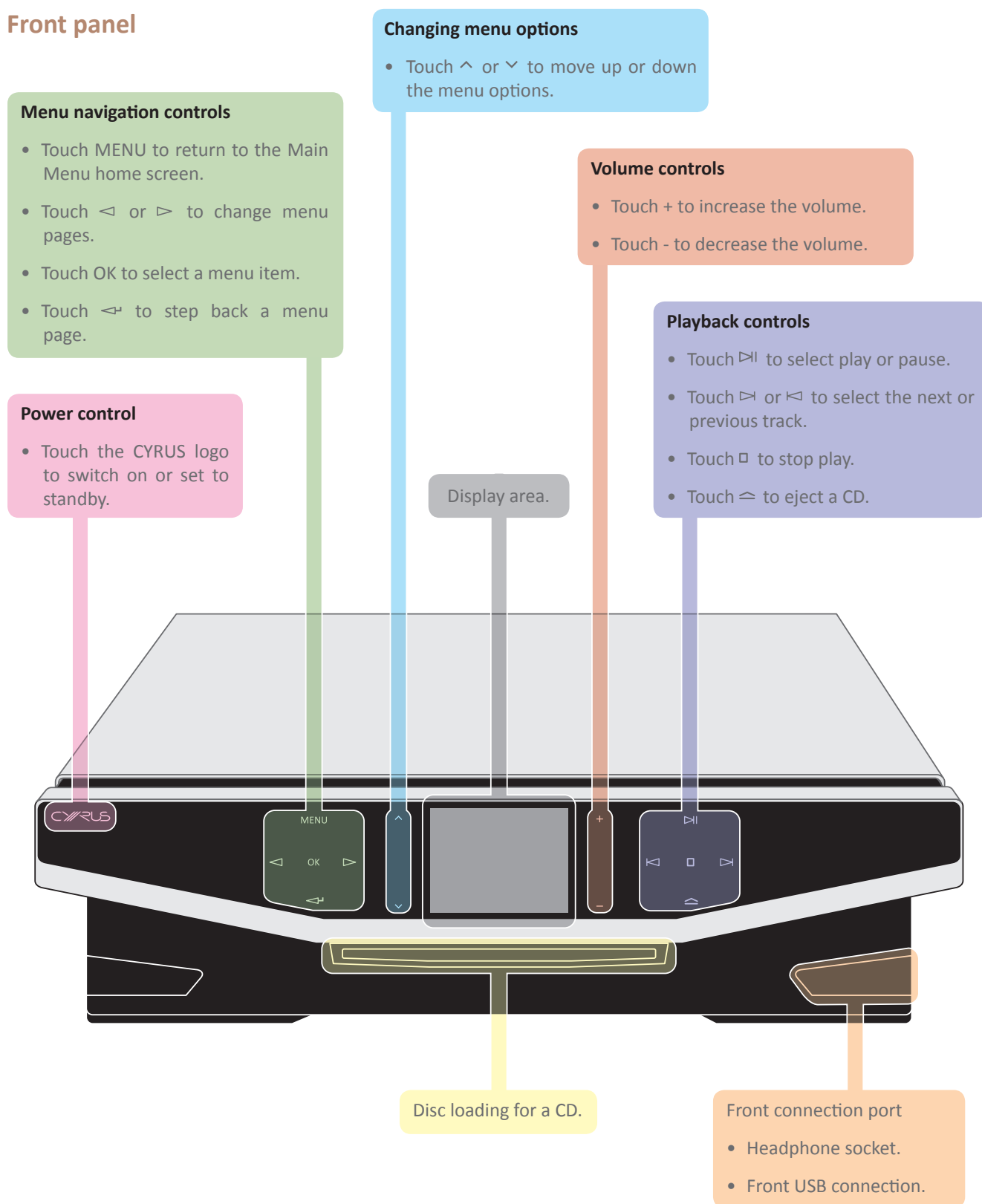

Remote control

introduction

The remote control fully operates all functions of **Lyric**.

The illustration on the next page shows the key zones that control **Lyric** with a summary of commands available.

The remote control can also be programmed with the commands from two other remote control handsets. These will normally be for your TV and a satellite or terrestrial TV set-top box, programmed to the TV and SAT buttons. All keys may be programmed to control other devices using the TV and SAT systems, with the exception of the CONTROL and SOURCE groups.

Remote control backlight

The remote control keypad includes a backlight. The backlight will switch on automatically when moved or when a command is sent.

Fitting batteries to the remote control

The battery compartment is on the back of the remote control.

1. Press the catch on the battery cover and lift off the cover.
2. Slide a AAA battery under the retaining hook in the upper half of the battery compartment as shown.
3. Fit a second AAA battery into the remaining space.
4. Replace the battery cover.

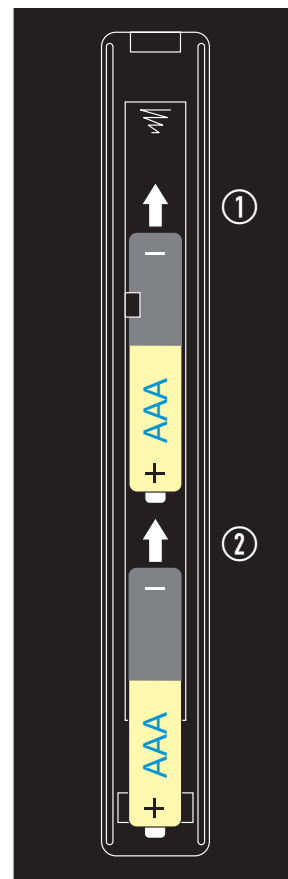

Battery replacement

If the backlight begins to flicker when sending a command, the batteries will soon need replacing.

Battery disposal

Replace the handset batteries only with AAA batteries of the same voltage and type.

Discard used batteries in accordance with recycling regulations in force in your area.

Remote control commands

Source select

- Press to stream music from a network.
- Press again to select *Bluetooth* operation.
- Press to play a CD.
- Press to play internet radio.
- Press again to select DAB/FM radio.
- Press to select Aux inputs.

Navigation

- Press to return to the Main menu.
- Use the cursor keypad to navigate menu options.
- Press to step back through menu screens.

Volume and balance

- Press + or - to set the volume level.
- Press to mute the sound.
- Press to change the balance setting.

Numeric keypad

- Number entry keypad for direct access track selection etc.

Store favourites

- Stores your favourite tracks into a local playlist when playing from your network library.



Power control

- Press to switch on or set to standby.

System select

- Press CYRUS to control *Lyric*.
- Press TV to send commands to a TV.*
- Press SAT to control a satellite receiver.*

*Commands are programmable.

Feature select

- Press to switch off the backlight.
- Press to jump to the EQ menu.
- Press to set shuffle.
- Press to set repeat.

Recall favourites

- Quick access to favourite tracks you have stored.

Aux input selection

- Quick access to step between Aux inputs (if an Aux input is already playing).

Playback control

- These buttons control playback of streamed music and CD.

Setup

- Initialises a setup sequence to learn commands from other remote controls. Refer to the next section for more details.

Learning TV and satellite commands

In addition to controlling **Lyric**, the remote control can learn the commands from two other remote control handsets. These will normally be a TV and a satellite or terrestrial TV set-top box, programmed to the TV and SAT buttons.

All keys may be programmed with the exception of the groups marked CONTROL and SOURCE and the SETUP key.

Preparation for learning

Check the following points before attempting to learn any commands:

- Check that both remote controls have fresh batteries.
- Choose a location on a tabletop that is not brightly lit. Subdued light is better, away from bright natural or indoor lighting.
- Check that you have enough time to spare to complete the learning process for all the keys you want to use.

Learning commands

In this example, the **Lyric** remote control will be learning commands from a 'reference' satellite receiver remote control.

1. Set the two remote controls up facing each other, spaced by about 5cm.

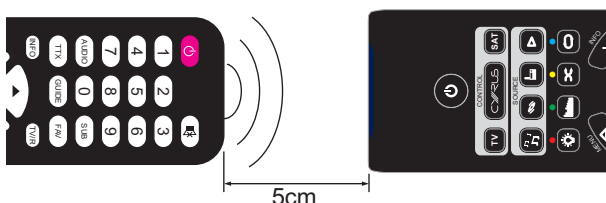

2. Press the TV or SAT key to select the mode that you want to programme.

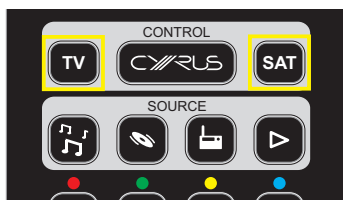

The keypad will light and the key you selected will be red.

3. Press and hold the SETUP key.



The mode key will change to white. After about three seconds, the mode key will light red again. This indicates that the remote control is ready to learn codes.

4. Release the SETUP key.

The remote control is now waiting to learn commands. The keypad will light continually and the mode key will light red.

5. On the reference remote control, press and hold the first key you want to learn (for example, volume up) until the mode key flashes red.

This indicates that the command has been received.

6. Release the key on the reference remote control.

7. Press a key on the Cyrus remote control (volume up in this example) to select where you want to save that command.

The mode key will stop flashing. This indicates that the command has been saved successfully.

If the learning process was successful, the remote control will be ready to learn the next command.

8. Repeat steps 5 to 7 for each command you want to learn.

When you have completed learning all commands -

- Press the SETUP key.

The mode key will change to white. After a few seconds the backlight will switch off.

Learning TV and satellite commands (cont'd.)

Checking programmed commands

- Select the mode that you just programmed and check that the commands were learned successfully.

NOTE: The TV or SAT mode key should flash red when sending a command. If the mode key is not flashing, then the command has not learned correctly.

- Make a note of any commands that have not programmed correctly and repeat the learning process to add these in.

NOTE: When you start the learning process it does not erase any programmed keys so you can re-programme individual keys if required.

Problems with learning

If none of the commands have been learned correctly, try re-starting the learning process again. Test a few keys first to ensure that your handset is compatible for learning. If the test works then continue to programme the rest of the commands you need.

If you still have problems, check carefully that the mode light is flashing correctly as you send a command to learn. If not, it may be that the batteries need replacing in the reference handset or that the spacing between the handsets is not ideal. Try adjusting the spacing between the handsets and repeating the learning process.

If you continue to have problems, it may be that your handset is incompatible with the learning process. This could happen with an older design of handset or one that has an unusual code-set.

Sending TV or SAT commands

Once you have programmed all the keys with the commands you want, you can use the remote control to send commands to your TV or satellite receiver etc.

- Press the TV or SAT key to select the mode you want.
- Press the command key.

The mode key will flash red when sending a programmed command.

Operation

Front panel controls

The front panel controls are backlit touch areas that light when the unit is operational. Hold your finger on one of the control icons to operate **Lyric**.

Remote control

The remote control duplicates all controls on the front panel and adds additional functions.

In the following sections, all operations are described when using the remote control. Front panel operation will be shown in brackets where different.

Menu navigation

The menu navigation group of keys, including a cursor keypad is used to quickly navigate menu screens on **Lyric**.

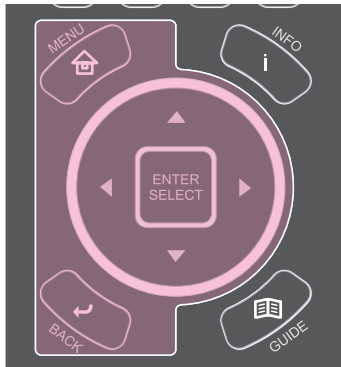

Alphanumeric character entry

Some functions and menu options will require you to enter alphanumeric characters. When this occurs, a 'keyboard' will be displayed to enable you to enter the characters.

Entry of a wireless network password is shown in the example below:

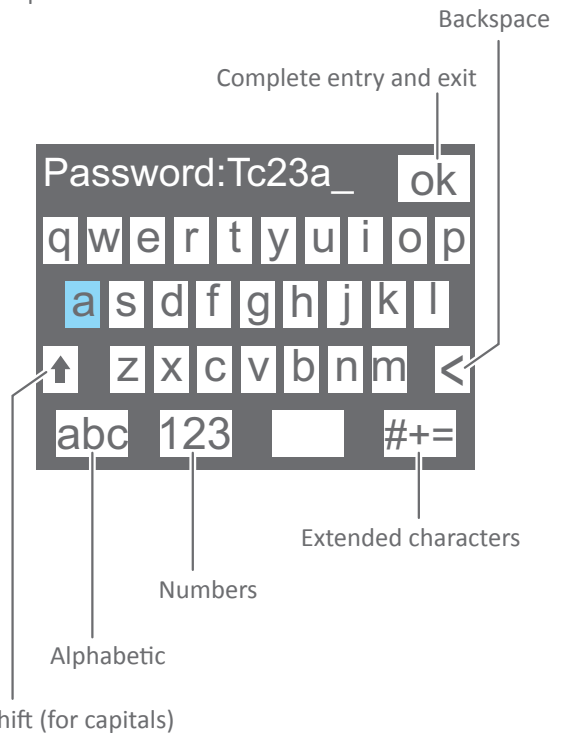

- Using the navigation controls, select and enter the characters required.

Lower case letters are entered from the keyboard screen.

Switch the keyboard between lower and upper case (capital) letters by selecting the 'shift' key.

Switch the keyboard to display numbers by selecting the '123' key.

Switch the keyboard to display extended characters by selecting the '#+= ' key.

- When all characters have been entered, select 'OK' from the keyboard.

Power

When power is first applied, **Lyric** will initialise, displaying the Cyrus logo, then set to standby.

The Cyrus logo will light red.

To switch Lyric on from standby

- Press  (or touch the CYRUS logo on the front panel).

Lyric will switch on and the front panel touch controls will light.

In regular use

Where possible, **Lyric** will return to the same source and menu display set before standby.

First use

Lyric will switch on, set to the 'Optical 1' Aux input.

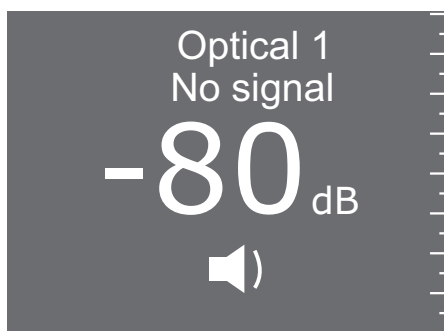

To set Lyric to standby when operational

- Press  (or touch the CYRUS logo on the front panel).

The unit will set to standby and the Cyrus logo will change to red.

In regular use the unit should be connected permanently to the mains power supply. When left unattended for a long period (holidays etc), it should be disconnected from mains power.

When switched to standby, or if disconnected from the mains, network settings and settings for input selection and volume/balance are retained.

Standby modes

The factory set standby mode is 'Low power standby'. This ensures that minimum power is always drawn when **Lyric** is set to standby.

If an iPad remains connected to the last-used USB port when **Lyric** is set to standby, low power standby will be deferred to allow the iPad to charge.

NOTE: Through the Setup menu, low power standby can be disabled. In this case, power will be supplied to USB devices that are connected during standby (for charging etc).

Display backlight

Proximity sensor

Lyric has a proximity sensor that can detect movement in range of the front panel. As supplied, this will automatically change the display mode when playing music from a network.

You can also choose to auto-switch the front panel and display backlights with the proximity sensor. To learn more about these settings, refer to the Setup > Proximity sensor section for more details.







Manual control of the backlight

- Press  to switch the front panel and display backlights on or off.

The backlight will switch on or off.

Selecting a source

Direct access from the remote control

- Press one of the Source buttons -
The source will change:
- Press  to select network streaming. Press  repeatedly to switch between network streaming and **Bluetooth** sources.
- Press  to select CD.
- Press  to select radio. Press  repeatedly to switch between internet (TuneIn) radio and DAB/FM radio.
- Press  repeatedly to step through the digital, USB and analogue Aux inputs.

From the source menu

- Press .
(or touch MENU on the front panel).
The Main Menu homepage will be displayed.
- Select the 'Source' option.
The Source list will be displayed.

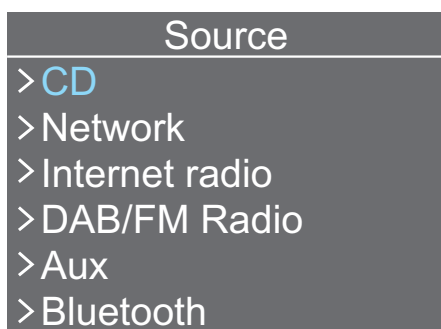

- Select the source you want from the list.
The source will be selected.

NOTE: When you select Aux operation from the front panel, **Lyric** will play the last-used Aux source. It is necessary to use the remote control if you want to change to another Aux source.

Volume control

To increase the volume

- Press + on the  button.
(or touch + on the front panel)
The volume will increase.

To decrease the volume

- Press - on the  button.
(or touch - on the front panel)
The volume will decrease.

The volume display of volume level with a bar graph will be shown briefly when changes are made to the volume setting.

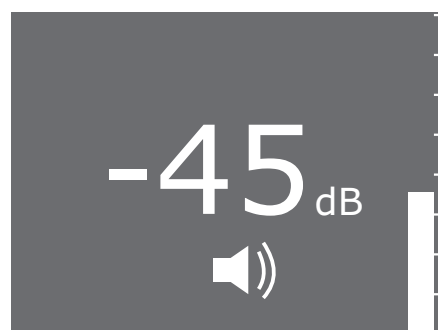

NOTE: If the volume level is higher than -30dB when set to standby, the level will be reduced automatically to a safer level of -30dB for next use.

Balance control



You can change the channel balance by up to 4dB in either direction.

- Press .

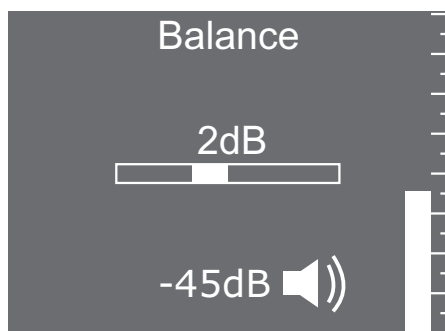
The balance setting will be displayed.



In the example, balance is shifted 2dB to the left.

- Press  repeatedly to move the balance towards the left in 1dB steps.
- Press  repeatedly to move the balance towards the right in 1dB steps.

NOTE: After the 4dB setting, one further step will swing the sound balance completely to the left or right speaker.

- Press  to store the balance setting and exit.

NOTE: Balance is normally set from the listening position using the remote control, but can also be set from the front panel via the Setup menu. Refer to the Setup > Balance section for more details.

Mute

- Press .

The sound will mute and the mute symbol will be displayed.



- Press  again.

The sound will un-mute.

NOTE: If the volume level is higher than -30dB when mute is set, the level will be reduced automatically to a safer level of -30dB when un-muted.

Playing a CD

Selecting CD operation

- Press  to select CD operation. (or select CD operation from the front panel via the Source menu).

Loading a disc

- Check that the display reads 'NO DISC', indicating that a disc is not already loaded.
- Hold the disc label side upwards and place it gently into the CD loading slot.

Once a third of the disc is loaded, the disc will be automatically loaded through the front panel.



The display will show the total number of tracks and playing time for the disc.

Ejecting a disc

- Press . (or touch  on the front panel).

The disc will be ejected.

Playing a disc



- Press  to play the CD. (or touch  on the front panel).

Playback will begin from track 1 unless otherwise selected.

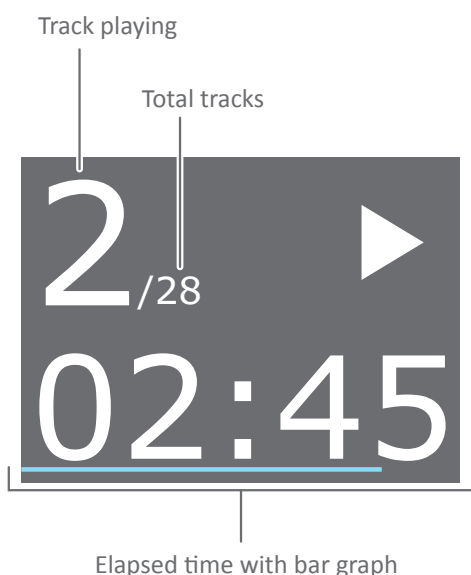

The display will show track and time information.







Pausing

- Press  to pause playback. (or touch  on the front panel).

The disc will be held at the point of interruption and the PAUSE symbol will show on the display.

- Press  to continue playback. (or touch  on the front panel).

Next/previous track selection

- Press  or  to select the next or previous track. (or touch  or  on the front panel).



The track playing will be indicated on the display.

Skip to a track number

- Enter the track number from the numeric keypad.

Play will skip to the selected track.



Fast forward/reverse search

- Press  or  to search forward or backward through a track.



The search will commence initially at a slow speed increasing after a few seconds if the key is held down.

The search keys will also search through next or previous tracks if held down long enough.

Repeat

- Press  to set repeat mode.  will be displayed. *The disc will now repeat continually.*
- Press  again to cancel repeat mode.

Shuffle

- Press  to set shuffle mode.  will be displayed. *The tracks will now play in a random order.*
- Press  again to cancel shuffle mode.

Stopping play

- Press  to stop play. (or touch  on the front panel).

Play will stop immediately.

Selecting DAB or FM radio



Select DAB/FM operation

- Press  twice to select DAB/FM radio. (or select DAB/FM operation from the front panel via the Source menu).

For first time use, the DAB/FM Radio menu will be displayed, otherwise the radio will tune to the last band and station playing.

Changing between DAB and FM bands

When playing a radio station.

- Press  (once from FM radio, twice from DAB radio). (or touch  on the front panel).
- Select 'Main Menu' from the options listed.

You can now select the DAB or FM band.

Listening to DAB radio

- Select the DAB band

First time use

When DAB radio is first selected, a full scan will begin of all bands for all available DAB station multiplexes. The details of stations found will be stored.

NOTES:

You can re-scan at any time to update the station list with any recent changes.

If you move to a different area it will be necessary to reset the DAB radio. This will erase the station list and start a full scan for stations in the new area.

For more details about scanning and resetting, refer to the options menus on the following pages.

Station list

When the initial scan is completed, a list of stations found will be displayed in alphabetical order (example shown).



If stations become unavailable, a question mark will be displayed next to the station name as shown with the top stations in the station list example. Invalid station names can be removed by selecting the 'Prune' option from the DAB Options menu.

Selecting a station

- Step up or down the station list until the station you want is highlighted.
- Select the station.

The radio will re-tune to the station you selected.

The station name and details about the station will be displayed with a signal strength bar graph.

DAB scrolling text will be shown at the bottom of the display (when available).





Returning to the station list

- Press . (or touch  on the front panel).

DAB options menu

Opening the DAB options menu

- When listening to a DAB station, press  twice. (or touch  on the front panel).

The DAB options menu will open.

The options available are explained in more detail below:

Station List

- Select this option to return to the station list.

Local Scan

NOTE: A local scan will only cover local bands in the UK. For other markets always use the 'Full scan' option.

- Select this option to start a local scan of the bands in your area and update the station list.

When the scan has completed, play will resume with the first station in the station list.

Full Scan

- Select this option to start a full scan of all available bands and update the station list.

When the scan has completed, play will resume with the first station in the station list.

DRC

DRC is Dynamic Range Compression. Enabling DRC will reduce the dynamic range and may improve the sound when listening to quieter stations at lower volume levels.

- Select 'High' or 'Low' to enable DRC. Select 'Off' to disable DRC.

Station Order

There are three selectable options to change the way the station list is presented - 'Alphanumeric', 'Ensemble' and 'Valid'.

- Select 'Alphanumeric' to display all stations in alphanumeric order.
- Select 'Ensemble' to display all stations in a sequence grouped by ensemble (multiplex).
- Select 'Valid' to display only valid stations.

Prune station

Your station list may include stations that you can no longer receive (marked with a question mark in the station list).

- Select the 'Prune' option to remove these stations from the station list.

Main Menu

- Select this option to return to the main menu and change band or reset the radio section.

Listening to FM radio

- Select the FM band.

FM scan tuning

- Press ► or ◀.
(or touch ▷ or ◀ on the front panel).

The tuner will scan the band and stop automatically at the next station.

Station information will be displayed.

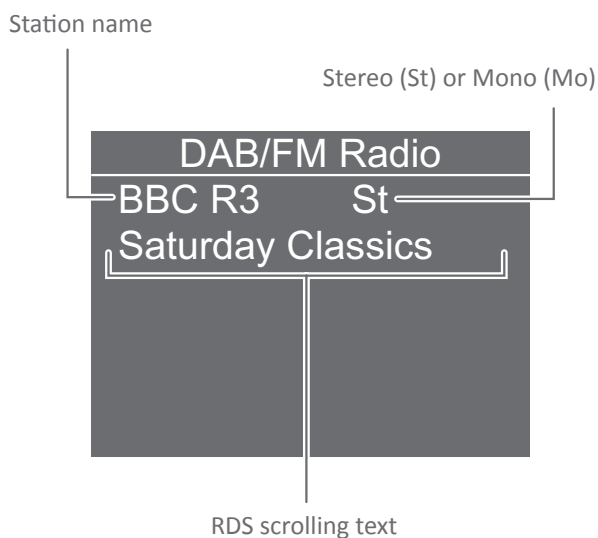

NOTE: You can change the FM scan sensitivity in the FM Options menu if required.

FM step tuning

- Press ▲ or ▼.
(or touch ▲ or ▼ on the front panel).

The tuner will step up or down the band in .05MHz steps.

FM options menu

Opening the FM options menu

- When listening to an FM station, press ↵.
(or touch ↵ on the front panel).

The FM options menu will open.

The options available are explained in more detail below:

Scan setting

- Select 'Strong stations' to skip weaker stations when scanning the FM band.
- Select 'All stations' to stop scanning at all signals found.

Audio setting

- Select 'Stereo or mono' to let **Lyric** automatically switch to mono for weaker FM stations.
- Select 'Mono only' to force all FM stations to play in mono.

This may be helpful to reduce a high background noise level if signal level is weak.

Main menu

- Select this option to return to the main menu and change band or reset the radio section.

Re-setting the radio

If you move to another area it is advisable to reset the radio section. This will erase the current station list and re-scan. A new station list will be compiled after the reset.

To reset the radio

When playing a radio station -

- Press ↵ (once from FM radio, twice from DAB radio).
(or touch ↵ on the front panel).
- Select 'Main Menu' from the options listed.
- Select the DAB/FM reset option.
- Confirm if you want to go ahead and reset the radio.

After reset the tuner will re-scan the DAB band and save a fresh station list.

Playing Aux sources

Aux sources are external sources you may have connected to **Lyric**.

The Aux sources are - Optical 1, Optical 2, Coaxial 1, Coaxial 2, iPad (Front), iPad (Rear), USB B, Analogue.

To select an Aux source

- Press the  source key repeatedly to step through the Aux source options listed. (or select Aux operation from the front panel via the Source menu).

NOTE: When you select Aux operation from the front panel, **Lyric** will play the last-used Aux source. It is necessary to use the remote control if you want to change to another Aux source.

Playing a digital Aux source

- Select the digital source you want to play.
- Set the source to play.

When a valid signal is detected, the sample rate will be displayed.

Playing an iPod/iPhone/iPad

These devices will be connected via the front or rear USB A port.

- Select the Aux source for the connection port you have used ('iPad Front' or 'iPad Rear').

The iPad music selection menu will be displayed.

- Use the menu navigation buttons to control the iPad and choose the music you want to play.

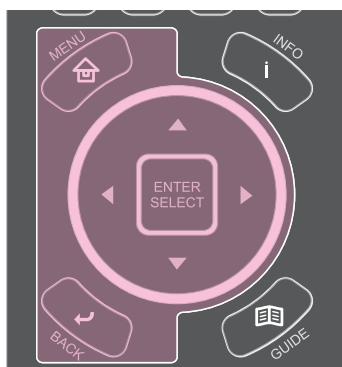

(Playback control is also possible from the front panel navigation controls).

Playing other USB sources

USB sources are USB devices which contain a library of music files. These may be a USB external hard-drive, a USB flash-drive or a personal audio player which has USB connectivity.

The source will be connected via the front or rear USB port marked 'iPad front' or 'iPad rear'.

- Select the Aux source for the connection port you have used.

***Lyric** will search the source and create an index of the music files found. This may take some time if the drive is a larger hard-drive.*

If the music is stored on the drive in folders (by album or artist), a list of the folders will be displayed.

If the music files are not stored in folders (all stored in the 'root' folder of the drive), the files will be displayed.

- Navigate the folders and files to find the music you want and select a track to play.

Play will continue through the folder containing the track.

Playback control

- When music is playing, use the playback control buttons to play, pause and select or search a track.

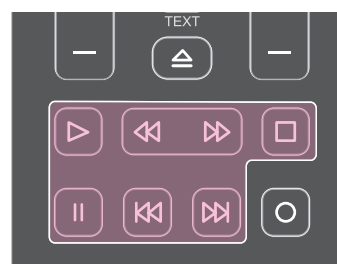

(Playback control is also possible from the front panel playback controls).

Playing a computer or laptop

- Select the 'USB B' Aux source.
- Switch on the computer.

When first used there may be a short delay while the computer installs a driver.

- Set the computer or laptop to play.

The music will play and the sample rate and volume level will be displayed.

Playing an analogue Aux source

Select the 'Analogue' Aux source.

- Set the source to play.

The input name and volume level will be displayed.

Streaming music from a network

Selecting network streaming

Note: To play (stream) music from a local network library, **Lyric** must be connected to a computer network that includes a music library managed by a uPnP server.

- Press  to select network streaming.

In regular use

Lyric will search for music servers.

- Skip to the 'Select a network music server' section.

First time use with a cabled network

If you have connected **Lyric** to your network by cable, **Lyric** should have already joined your network.

- Skip to the 'Select a network music server' section on the next page.

First time use with a wireless network

If you have not connected to your network by cable, 'Not connected, see network setup menu' will be displayed.

You will now need to choose your wireless network and enter the password.

- Press .
(or touch MENU on the front panel).

The Main Menu homepage will be displayed.

- Select the 'Setup' option.

The Setup menu will be displayed.

- Select the 'Network' option

The Network menu will be displayed.

- Select the 'Wireless' option.

Lyric will run a site survey and list all the wireless networks found within range.

- Use the navigation controls and select your wireless network from the list.
- A keyboard will be displayed to enable you to enter the password for your network.
- Using the keyboard on the display, enter the password.
- When all characters in the password have been entered, select 'OK' from the keyboard.

Lyric should now join the network.

*In regular use, **Lyric** will automatically re-join your wireless network.*

- Skip to the 'Select a network music server' section on the next page.

If no network is found

If **Lyric** does not join your wired or wireless network successfully, refer to the trouble-shooting section before proceeding.

Streaming music from a network (cont'd.)

Select a network music server

A list of the UPnP servers found on NAS drives and computers connected to your network will be displayed as in the example below.

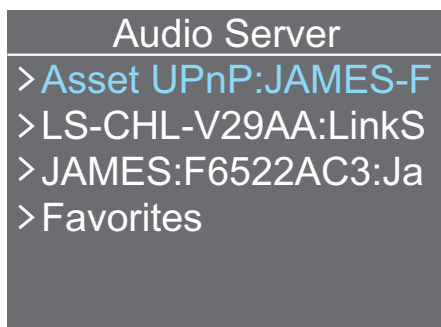

If **Lyric** has joined your network, but no UPnP servers are found, only the 'Favorites' option will be displayed.

If no servers are found, refer to the 'UPnP server trouble-shooting' section.

- Select the server you want to use.

You can now choose how to browse your music. The browsing options you see will be those offered by the server you selected, but will typically allow browsing by album, artist, genre, playlist etc.

Browsing for music

- Choose a browsing option from the list.
- Continue to navigate to the album, track or genre you want to play.

Playing music

- Press **▶** to play the highlighted option. (or touch **▶** on the front panel).

If you choose an album or genre etc., all tracks in the collection will play.

If you choose a track within an album, play will continue through the remainder of the album containing the track.

Track and time information will be displayed initially.

If the proximity sensor is enabled, the display will switch to show cover art (if this is available from the library in a compatible format). The display will return to track and time status when you approach the front panel.

If the proximity sensor is disabled, the track and time status information will be superimposed over the cover art.

Browsing for a new selection

- To step back through the selection menus, press **←**. (or touch **←** on the front panel).

Pausing

- Press **⏸** to pause playback. (or touch **⏸** on the front panel).

Play will be held at the point of interruption and the **PAUSE** symbol will show on the display.

- Press **▶** to continue playback. (or touch **▶** on the front panel).

Next/previous track selection

- Press **⏮** or **⏭** to select the next or previous track. (or touch **⏮** or **⏭** on the front panel).

The track playing will be indicated on the display.

Fast forward/reverse search

- Press **⏩** or **⏪** to search forward or backward through a track.

The search will commence and continue while the key is held down.

Stopping play

- Press **⏹** to stop play. (or touch **⏹** on the front panel).

Play will stop immediately.



Favourite tracks

The favourites feature enables you to quickly store your favourite tracks for recall on the favourites playlist.

To save a track to your favourites

- While the track is playing, press STORE.
The track will be saved to your favourites playlist.
- Continue to save your favourites in this way.

To play your favourite tracks

- Press .
The favourites playlist will open.
- Press  to play all your favourites or select a track to play from the playlist.
The track(s) will play.
If you selected a single track, play will continue from this point.

NOTE: Track selection, pause and other playback control functions will operate as normal within the favourites playlist.

To delete a track from your favourites

From the favourites playlist -

- Navigate to the track you want to delete.
- Press STORE.
The track will be deleted from your favourites playlist.

Playing TuneIn (Internet) radio

Note: To play internet radio, **Lyric** must be connected to a computer network that has internet access.

- Select internet radio.

After a short delay, the internet radio categories are displayed. You can browse for a station, searching by location (country), genre etc.

- Choose your preference of category to search for the station you want.

Further categories or a station list will be displayed.

- Continue to navigate to a station you want to hear.

- Select the station.

*After a short delay, **Lyric** will tune to the station. If the station broadcasts a logo, this will be displayed.*

Browsing stations

- Press **⏮** or **⏭** to step through the stations in the current station list.

Favourite station presets

Favourite station presets may be saved for recall through the TuneIn website at www.tunein.com.

Registering Lyric with TuneIn

The internet radio service for **Lyric** is provided by internet radio specialists TuneIn.

If you register your **Lyric** at the TuneIn website, you can set up a preset library online that will be downloaded to your **Lyric** when you select internet radio.

To register your Lyric at TuneIn

- Select Internet Radio.

The list of categories is displayed.

- Choose the 'Account Association' option from the TuneIn Radio menu.

After a short delay, a registration code will scroll across the screen. Make a note of this.

- Visit the TuneIn website at www.tunein.com and set up an account.
- Log in to your account, go to 'Settings' and you will see the Devices tab.
- Select this option.
- Choose to add a device.
- Enter the registration code when prompted.

*You will now see confirmation that your **Lyric** is registered as a device.*

Saving and recalling internet radio presets

You can now use the search facility on the TuneIn website to browse for stations, save your favourites as presets and create folders to manage the presets.

If you have successfully registered **Lyric** and saved groups of presets, a new category 'My Presets' will be added to the TuneIn Radio menu.

This category will include all of your favourite stations, organised in the groups you have created online. The preset groups will be updated whenever you make any changes to the presets saved under your TuneIn login.

NOTE: If you want to register **Lyric** to a different account, it will be necessary to visit the TuneIn website, log in and remove the previous registration, before re-registering to a new account.

Playing a *Bluetooth* source

Many mobile sources and laptop computers include connectivity for **Bluetooth** devices. These sources can be connected to **Lyric**. Once connected, music from the source may be played through the **Lyric** system.

Selecting the *Bluetooth* source

- Press  twice to select the **Bluetooth** source.

Lyric will start to search for local **Bluetooth** devices.

Pairing with a *Bluetooth* source

Before playing from a **Bluetooth** source, it will be necessary to pair the source to **Lyric**.

- Activate **Bluetooth** mode on the source.

*If the source is a phone, **Bluetooth** mode will normally be activated in the connectivity section of the settings menu.*

*If the source is a computer, **Bluetooth** settings should be found in the control panel.*

In the **Bluetooth** menu of the source, there should be an option to search for **Bluetooth** devices.

- Select this option.

*The source will now scan for other **Bluetooth** devices and should find the unit, identified as 'Lyric'.*

*If you change the name of your **Lyric**, the **Bluetooth** name will also change. Refer to the 'Setup' section for more details of changing the name.*

- Choose to pair with this.

*If the device features **Bluetooth** technology earlier than V2.1, you will be asked for a password.*

- If so, enter 0000.

*Your **Bluetooth** source will now be connected to **Lyric**.*

*After pairing for the first time, **Lyric** will appear in the connection menu of your **Bluetooth** device.*

Re-connecting

Your device and **Lyric** should re-connect when next used if no other device is connected.

Playing music

Once your device is connected to **Lyric** you can select the music you want to play from the device and set the volume level etc. from **Lyric**.

NOTE: If you set **Lyric** to play another source, your **Bluetooth** source will remain connected to **Lyric** until you disconnect it or move out of range.

Cadence

Cadence is an advanced application that may be installed on Apple mobile devices that are running iOS 6.0 or later or Android mobile devices running V2.2.x Froyo or later.

With a full graphic, interactive display, **Cadence** uses your hand-held device to extend the display and controls from the **Lyric** front panel to the comfort of your listening chair.

Cadence enables you to take full control of source selection, music browsing from network or connected devices, radio station tuning and volume control. Graphic content such as album artwork (where available from a network library or connected device) is displayed.

Cadence is a free application, available from the App store, and is a must-have for owners of Apple devices. To learn more about **Cadence**, refer to the Cyrus website at www.cyrusaudio.com.

Setting up Lyric

The Setup menu enables you to change settings to best match your system and listening preferences.

In this section, the options are explained for all available settings.

The Setup menu

- Press .
(or touch MENU on the front panel).

The Main Menu homepage will be displayed.

- Select the 'Setup' option.



The Setup menu options will be displayed.

Navigating the Setup menu

- Use the navigation buttons on the remote control to find and select the options you want to change.
(or touch the navigation icons on the front panel).

When you are changing the settings, the options will not time out. This ensures you have enough time to make any changes.

To step back through the Setup menu

- Press  repeatedly at any time to step back through the menus.
(or touch  on the front panel).

To exit the Setup menu

- Press .
(or touch MENU on the front panel).

The Main Menu homepage will be displayed.

Setup > Network

Setup > Network > Wired

NOTE: The 'Wired' menu option will only be accessible when **Lyric** is connected to a network by cable.

- Select this option to change settings for a wired network.

The DHCP option will be displayed.

DHCP automatic IP address assignment (DHCP ON)

The factory setting for DHCP is 'DHCP ON'.

CAUTION! Most modern home networks will require clients to be set for DHCP automatic address assignment (DHCP ON). When set in this way, your network host (usually your modem/router) will be able to automatically assign IP addresses to network clients (including **Lyric**). There should be no reason to set 'DHCP OFF' in **Lyric**, unless you know that your network has been configured to require a fixed IP address.

Assigning a fixed IP address (DHCP OFF)

Before setting DHCP 'OFF', ensure that you fully understand manual assignment of a fixed IP address, and know a free IP address that can be allocated to **Lyric**. Assigning an existing IP address to **Lyric** manually may cause conflict with other network devices. If you are uncertain about the requirements for your network, always contact an IT professional.

- Uncheck the 'DHCP ON' option to enable manual network configuration.
- Enter the IP address in the format nnn.nnn.nnn.nnn using the keyboard display.
- When you have completed entry of the IP address, select the 'OK' option from the keyboard.

The display will now prompt for a subnet mask.

- Follow the same procedure to enter the subnet mask in the same format.

The display will now prompt for a gateway address.

- Follow the same procedure to enter the gateway address in the same format.

The display will now prompt for a DNS1 address.

- Follow the same procedure to enter the DNS1 address in the same format.

The display will now prompt for a DNS2 address.

- If you want to enter a DNS2 address, follow the same procedure as the DNS1 address in the same format.

*Once the last entry is completed, **Lyric** will join the network using these settings.*

NOTE: If **Lyric** has been set with a fixed IP address, these settings must be changed, or DHCP re-enabled if **Lyric** is subsequently connected to a different network, depending on the network requirements.

Setup > Network (cont'd.)

Setup > Network > Wireless

NOTE: The 'Wireless' option will not be accessible when **Lyric** is already connected to a network by cable.

- Select this option to set up a wireless network connection or to change to another wireless network.

A list of available wireless networks will be displayed. A signal strength bar graph will be shown for each available network.

- Use the navigation controls to select your wireless network from the list.
- A keyboard will be displayed to enable you to enter the password.
- Using the keyboard on the display, enter the password.
- When all characters in the password have been entered, select 'OK' from the keyboard on the display.

***Lyric** should now join the network.*

Setup > Network > Status

NOTE: The 'Status' option will only be accessible when **Lyric** is connected to a network.

- Select the status option to display the current status of the network.

The network status will be displayed.

Setup > Equaliser

The equaliser feature enables you to set the tonal characteristic of the sound with a five band frequency equaliser. The factory setting is for the equaliser to be disabled.

Enabling/disabling the equaliser

- Check the 'Equaliser enable' option to enable the equaliser.
- Uncheck the option to disable the equaliser.

Changing equaliser settings

- Select the 'Equaliser settings' option.
The equaliser settings will be displayed.
- Press ▲ or ▼ to select an equaliser frequency.
- Press ► or ◀ to increase or decrease the setting in 1dB steps.

Setup > Aux input names

Default input naming

When **Lyric** leaves the factory, the default input names are set to correspond to their connections, for example Optical 1, Optical 2 etc.

If you prefer, the name of any AUX input (including USB and analogue) may be changed to a choice from the following list-

CD, CD 1, CD 2, SACD, CD-R, DAB, Tuner, Satellite, Cable, iPod, MP3, DVD, DVD 1, DVD 2, Blu-ray, PVR, Video, Laser disc, TV, TV 1, TV 2, Projector, Games, Games 1, Games 2, PC, Laptop, Notebook, Mac, Phono, AV, Jukebox, Minidisc, Special, Aux, Default name (the input name assigned at the factory).

Changing Aux input names

- Select the 'Aux Input Names' option from the Setup menu.
The Aux inputs will be listed.
- Select the Aux input that you want to name.
You can now browse the list of available names.
- Select a name for this input.
The input will be named.
You can continue to name other inputs if required.

Setup > Speaker config

There are two options for speaker configuration -

2.0 channel (left and right speakers only).

2.1 channel (left and right speakers with a subwoofer).

Choosing a speaker configuration

- Select the option that matches your speaker system from the menu.

When you select an option the Speaker setting menu will be displayed. This menu is different for 2.0 and 2.1 channel speaker systems.

2.0 channel settings

If you selected 2.0 channels, you now have the option to configure the 2.0 channel settings for the primary output (speakers) or secondary output (the analogue output).

2.0 channel > Primary output settings

You can choose wideband sound for the speaker output or set an optional roll-off frequency.

- Uncheck the 'High pass filter' option to feed wideband sound to the system speakers (factory setting).
- Check the 'High pass filter' option to restrict the bass frequencies fed to the system speakers.

The roll-off frequency will be marked on the Filter bar graph.

- Highlight the Filter bar graph to change the roll-off setting.

You can set the bass roll-off in the range 60 Hz to 350 Hz.

2.0 channel > Secondary output settings

For a 2.0 speaker configuration you can set the Analogue line output to a Fixed or Variable level.

- Select 'Variable' if you have connected the Analogue output to an external power amplifier or subwoofer.
- Select 'Fixed' if you have connected the Analogue output to a tape recorder or to an amplifier feeding a second room.

Setup > Speaker config (cont'd.)

2.1 channel speaker settings

If you selected 2.1 channels, you now have the option to set the crossover frequencies for the main speakers, and the crossover frequency and gain settings for the subwoofer, connected to the analogue output.

When setting the crossover frequencies, it is advisable to activate both high pass and low pass filters and set the frequencies to the same values. This should ensure that bass content is evenly transferred between the main speakers and the subwoofer.

Setting both frequencies to a lower value will extend the bass from the main speakers and reduce the bass range from the subwoofer.

Setting both frequencies to a higher value will reduce the bass from the main speakers and increase the bass range from the subwoofer.

You can also select a gain trim option which enables you to set the relative volume of the subwoofer from your listening position.

NOTE: The left and right channel analogue outputs are dual mono when Lyric is set for 2.1 channel operation.

2.1 channel speaker settings > High and low pass

- Select the 'High pass' and/or 'Low pass' options to activate the high and/or low pass filters.
- Highlight the 'High pass' or 'Low pass' bar graph to change the filter settings.

You can set each filter in the range 60 Hz to 350 Hz.

2.1 channel speaker settings > Gain (sub)

If you find the subwoofer is too loud, this option enables you to reduce the subwoofer volume by up to 10dB, relative to the main speakers.

- Select the 'Gain' (Sub) option to enable gain (volume) setting of the subwoofer relative to the main speakers.
- Highlight the gain setting and change it to the value you require.

Setup > Balance

Select this option to display the Balance bar graph.

- Change the balance setting with the cursor controls.

NOTE: For quick access to balance setting, press  on the remote control.

Setup > CD play mode

For the factory setting, 'Autoplay' is disabled.

When 'Autoplay' is enabled, a CD will automatically play when it is loaded.

Changing the Autoplay setting

- Select the 'Autoplay' option.

The option status will be changed.

Setup > Backlight

For the factory setting, 'Auto Backlight' is enabled.

With this setting the backlight brightness will depend on the light conditions in your room. If the room is bright, the display will brighten up. If the room lighting is subdued, the display will dim.

Changing display backlight settings

- Select the 'Auto backlight' option.

The option will uncheck and reveal the 'Display backlight' and 'Panel backlight' options.

- Select one of the options.

The brightness setting will be displayed on a bar graph.

- Change the setting to suit your requirements.

As you change the setting, the display or panel light level will change.



Setup > Proximity sensor

Proximity sensor settings

For the factory setting, 'Proximity sensor' is enabled and 'Auto switch display' is disabled.

When the proximity sensor is enabled, **Lyric** will sense movement near the front panel and automatically change display mode when network streaming to switch between play status and cover art. When the proximity sensor is disabled, the play status display will be superimposed over cover art.

When 'Auto switch display' is enabled, the front panel and display backlights will fade when not in use. The proximity sensor will then switch the backlights on for a short period when the proximity sensor detects movement, a front panel control is touched, or when a remote control command is received.

NOTE: If 'Auto switch display' is disabled and the  button is pressed on the remote control, the display will switch off, and can only be re-activated by pressing  again.

Changing proximity sensor settings

- Select the 'Proximity sensor' option.

Check or uncheck the option as required.

Auto switch display

NOTE: The proximity sensor will be automatically enabled if this option is checked.

- Select the 'Auto backlight' option.

Check or uncheck the option as required.

Setup > Standby

For the factory setting, 'Low power standby' is enabled.

When this setting is enabled, power consumption during Standby is minimised.

NOTE: If an iPad remains connected to the last-used USB port when **Lyric** is set to standby, low power standby will be deferred to allow the iPad to charge.

When 'Low power standby' is disabled, power will be supplied to the USB A ports during standby to enable an iPad to be charged if it is connected.

Changing the Low power standby setting

- Select the 'Low power standby' option.

Check or uncheck the option as required.

Setup > Unit name

The factory setting for the unit name is 'Lyric'.

You can also choose to personalise the name.

NOTE: If the name is changed, this will also become the new device name when a **Bluetooth** device searches for Lyric.

To display the name

- Select the 'Unit name' option from the menu.

The current name will be displayed.

To exit without changing the name

- Press .
(or touch MENU on the front panel).

The Main Menu homepage will be displayed.

To change the name

- Select the name.

A keyboard will be displayed to enable you to enter a new name.

- Using the keyboard on the display, enter a new name.
- When all characters in the name have been entered, select 'OK' from the keyboard on the display.

The name will be changed.

Setup > About

- Select this option to display the model number and firmware versions for your **Lyric**.

*This information may be required should you need to arrange service or upgrades to your **Lyric**.*

To exit this screen.

- Press .
(or touch  on the front panel).

Setup > Factory reset

Selecting the 'Factory reset' option will return all **Lyric** settings to factory originals.

NOTE: After switching on it will take approximately 30 seconds before you can select factory reset.

To reset Lyric

- Select the 'Factory reset' option.

You will be asked to confirm.

If you confirm and continue, all settings will be returned to factory original settings and changes to the unit name etc will be restored.

Trouble-shooting

This section includes suggestions to resolve operational problems you may encounter when operating **Lyric**.

If you cannot resolve the problem, contact your Cyrus retailer in the first instance for advice.

No power

- Check that mains power is connected and that the outlet is switched on.

No backlight

- The display may be switched off. Press  to check.

No sound at all

- Check that the speakers are correctly connected and that there are no stray wires at the terminals on **Lyric** or the speaker that could touch and short-circuit.
- Check that the correct source is selected. Try a different source, for example play a CD.
- Check that the volume is turned up.
- Check that mute is not set.
- Check that headphones are not connected.

No sound from a digital input

- Check the status on the display. If the display shows 'No signal' then check the connections from the source and check that the correct source is selected.

No remote control operation

- The remote control may be set to operate TV or satellite systems. Press the CYRUS button and try again.
- The batteries may be drained. Check with a new set of batteries.

Remote control flashing

- When the remote control lights flash continually, the batteries should be replaced.

CD not loading

- A disc may already be loaded. Check and remove any disc before loading another.

CD not playing

- Eject the CD and check that it is loaded correctly with the label facing upwards.

No DAB radio stations

- Run a full scan to acquire a new station list.

DAB scanning can be selected from the DAB options menu.

If no station list is available after a full scan, the signal strength in your location may be too weak.

- Try moving **Lyric** to another location to check and scan again.
- If the signal cannot be improved in your preferred location, an outdoor aerial may be necessary.

Noisy FM reception

- This is probably due to a weak signal. Try other locations to check.
- If the signal cannot be improved in your preferred location, an outdoor aerial may be necessary.
- Setting to mono reception may help with marginal signal strength.

FM mono can be selected from the FM options menu.

USB drive navigation problems

When selecting a drive connected to the USB port, the message 'Unable To Browse' is displayed.

This message will be displayed if the format of the connected drive is not compatible with **Lyric**. In this case, the drive should be formatted as FAT16 or FAT32.

NOTE: Re-formatting the drive will erase all data contained on the drive.

Fault indications

Lyric includes self-diagnostic systems that can detect possible fault conditions. If a fault condition is detected, one of the following messages will be displayed:

DC offset fault

If this fault condition is displayed, disconnect **Lyric** from mains power, wait ten seconds and re-connect. If the fault persists, contact your Cyrus retailer for help to resolve the problem.

Over current fault

An over current fault may be due to a problem with the speaker cables. Disconnect **Lyric** and check around the terminals at each end of the speaker cables to ensure that there are no loose strands of wire that may touch together and cause a short-circuit.

If an over current fault is reported regularly when playing at high volumes, it may be that the impedance of your speakers is very low, causing the over current protection to activate.

PSU Service

If this fault condition is displayed, there may be a permanent fault within the power supply. Contact your Cyrus retailer for advice.

Temperature error

This fault condition is displayed if the amplifier overheats. In this case, switch off **Lyric** and leave it to cool for thirty minutes before checking again.

Network trouble-shooting

Unable to join a network

Before making any changes to fix a network problem, check the Network status display. This display is accessible from the Network setup menu and has diagnostic information about your network connection and can save you time finding the problem.

NOTE: If there is no cabled network available and no wireless networks in range, the status display will not be accessible.

Check particularly -

- Is the status of your network shown correctly (wired or wireless).

*If you have recently changed between wired and wireless networks you will need to disconnect **Lyric** from mains power and re-connect after 10 seconds. Allow **Lyric** to re-start, then check status again.*

*If you have a wired network that has not registered, it may be that there is a wiring problem between **Lyric** and your router/modem. Check that the connections are secure and if you can find no problems, connect a computer to the same wired connection and check if there is internet access through the network.*

- If the connection checks OK with a computer, does DHCP show as Enabled on the status screen? If so, network settings should have been assigned to **Lyric** automatically by your network.

*If DHCP is disabled, try enabling DHCP (refer to the Setup > Network section). If there are still problems joining the network, then it is possible that your network is set for manual assignment of IP addresses, and it will be necessary to set DHCP 'OFF' and assign an IP address to **Lyric** manually. This should only be attempted if you fully understand manual IP address assignment and have access to a range of free IP addresses that can be assigned to the **Lyric**. Refer to the Setup > Network section for full instructions to set a manual IP address.*

If you suspect that the network is configured for manual assignment of IP addresses, but don't have the knowledge or information necessary to assign an address manually, enlist the help of an IT professional.

- Check if a numeric address is shown next to IP:.

*If there is an address shown, **Lyric** has joined the network and should be able to browse for servers.*

Wireless network is not visible

If **Lyric** does not display your wireless network in the network list, or if no wireless networks are found:

- Check that an aerial is fitted to the wireless network aerial connector on the back panel.
- Move **Lyric** very close to the source of your wireless network (usually the modem/router).
- Re-connect the power and check if your network is found.

*If **Lyric** connects successfully when moved close to the wireless source, there may be inadequate signal strength in the original location. Cabled connection is recommended if this is the case.*

If the wireless network is still not visible when **Lyric** is placed close to the wireless source, it may be that the SSID (network name) of your wireless network is hidden. **Lyric** will not find a wireless network with a hidden SSID, so it will be necessary to re-configure the source of your wireless network (usually the modem/router) so that the SSID is visible. If you are not sure how to make these changes, enlist the help of an IT professional.

Intermittent playback from a network

This is most likely to be caused by inadequate network bandwidth.

If you are using a wireless network, it is probable that the signal strength is high enough, but may also be due to other wireless network users with high demands (large downloads etc).

To check signal strength, move **Lyric** close to the source of the wireless network and check performance. If the dropouts stop, then consider a cabled link between the modem/router and **Lyric**.

To check if other network users are restricting the bandwidth, test **Lyric** at a time when there are no other wireless users connected to the network.

NOTE: Lossless and uncompressed files demand more network bandwidth than compressed files. If the music only drops out when listening to these files, this may also indicate inadequate network bandwidth.

UPnP server trouble-shooting

UPnP music server not found

First check the Network status display to confirm that **Lyric** has joined your network successfully.

Check also that you know where your UPnP server is located.

If the server is located on a NAS drive, check the settings for the drive.

If the UPnP server software is located on a computer, check that the server software is correctly set up to share your music library on the network. The exact procedure to change library sharing will depend on the UPnP server software, but you will generally need to open the 'options' or 'preferences' section within the UPnP server software, locate the section for 'Sharing' and enable sharing for your preference of all devices, or just the Cyrus **Lyric**.

Once the settings are saved you should be able to find the server.

Internet radio trouble-shooting

Internet radio problems may occur for two reasons.

- There may be no connection to your local network (**Lyric** will require a network connection to receive internet radio).

*In this case, refer to the beginning of the 'Network trouble-shooting' section to determine why **Lyric** is unable to join your cabled or wireless network.*

- **Lyric** may have joined your network but the network may not have access to the Internet.

In this case, check the Gateway (Gtwy:) setting on the Network status screen (Setup > Network > Status).

*If the Gateway (Gtwy:) setting is 0.0.0.0, **Lyric** does not have access to a gateway to the internet. This may be due to a failure of the connection between your router/modem and the internet or it could be a problem with the internet service provider.*

Double-check the internet connection with a computer connected via the same network to confirm, this. Your internet provider should be able to provide some diagnostic help if there is a problem.

Firmware upgrades

The control system in **Lyric** is easily user upgradeable via the upgrade port on the back panel to add enhancements and new features as they become available.

Checking the current firmware version

To confirm that a firmware upgrade is a newer version than that currently installed, refer to the Setup > About section for details of the current firmware version installed in your **Lyric**.

Upgrading the firmware

To upgrade the firmware, use the mini-USB cable supplied with **Lyric**.

If firmware upgrades become available, news will be published on the **Lyric** pages of the Cyrus **Lyric** website www.cyruslyric.com with detailed instructions for you to prepare **Lyric** for a firmware upgrade and apply the upgrade via your computer.

Specifications

Lyric Features

CD readingCyrus SE₂ custom disc management
D/A converter..... 32 bit

Connectivity

NetworkWired ethernet RJ45 or Wi-fi 802.11g
Bluetooth versionA2DP
Digital inputs 2 x Toslink optical
..... 2 x RCA coaxial
Analogue input1 x RCA stereo
USB A 2 x ports for iPad, USB flash drive or HDD
USB B 1 x port for a computer

Network streaming

Compatible file formats
... WAV, AIFF, FLAC (up to 24 bit/192 k)
..... MP3 (up to 320kB/s VBR/CBR)
..... Ogg Vorbis, WMA, ALAC, AAC

Internet radio

Service provider TuneIn radio, full service

Radio tuner

CoverageFM Band II, DAB Band III and L-Band

Lyric Performance

Power supplySee rating marked on the unit
Power consumption 430 W
Dimensions 420 (W) x 105 (H) x 320 (D) mm
Weight..... 8.88 kg

Outputs

Output power//8 Ω..... 150 W
Output power//6 Ω..... 230 W
Pre out (max) 2.5 V

Digital inputs

THD+n (1 kHz, 50 W).....0.008 %
S/n ratio (ref 1W) -70 dB
Digital input voltage500 mV pk-pk
Digital input Impedance..... 75 Ω
Digital audio formats PCM stereo only
Sample rate range 32 k - 192 k

Analogue input

THD+n (1kHz, 50 W).....0.012 %
S/n ratio (ref 1W) -70 dB
Input sensitivity (for 170W output) 530 mV

Tuner

DAB tuning range (Band III)..... 174.928 - 239.200 MHz
(L-Band) .. 1452.960 - 1490.624 MHz
DAB sensitivity-100 dBm (typ)
DAB frequency response..... 20 Hz - 20 kHz
DAB THD+n 0.01 (typ)
DAB s/n ratio >95 dB
FM tuning range:..... 87.5 - 108 MHz
FM sensitivity-107 dBm (typ)
FM THD+n 0.15 % (typ)
FM S/n ratio: >64.5 dB
FM stereo separation:..... >30 dB

USB drive

Compatible formatsFAT16, FAT32

Cyrus reserves the right to change all specifications without notice. E & OE

Warranty

The warranty should be registered online within eight days of purchase. No retailer or distributor may vary the terms of this warranty, which is personal to the original purchaser and is not transferable.

Please retain the sales receipt as proof of purchase.

Warranty claims must, wherever possible, be made through the retailer from whom the equipment was purchased.

This warranty excludes:

- Damage caused through neglect, accident, misuse, wear and tear, or through incorrect installation, adjustment or repair by unauthorised personnel. Any unauthorised servicing will result in loss of warranty.
- Liability for damage or loss occurring in transit to or from the purchaser.
- Consequential damage, loss or injury, arising from or in conjunction with this equipment.

Equipment for attention under warranty should be consigned return carriage paid. If returned equipment is found to comply with the published specification, CYRUS reserves the right to raise a charge.

The above conditions do not affect your statutory rights as a consumer.

Disposal



This logo means that this product is not to be disposed of with your household waste. This product should be handed over to a designated collection point to be recycled. Your cooperation in the correct disposal of this product will contribute to the effective usage of natural resources. For more information on collection points, contact your disposal service or local government administration.



LYRIC | STREAMING AUDIO SYSTEM

Thank you for selecting Cyrus.

Cyrus Audio Ltd.
Ermine Business Park,
Huntingdon,
Cambridgeshire PE29 6XY
England



Tel: +44 (0)1480 410900
email: info@cyrusaudio.com
www.cyruslyric.com